



## **SURGICAL INSTRUMENTS**

## **CATALOGUE**

✉ [info@simzmedicalsupplies.com](mailto:info@simzmedicalsupplies.com)

🌐 [www.simzmedicalsupplies.com](http://www.simzmedicalsupplies.com)

## About Our Company



SIMZ medical supplies Co. is a trading company that is committed to delivering quality medical supplies. SIMZ prides itself in delivering single use and reusable Dental, Surgical and Orthopedic instruments. Our products are manufactured by using the highest quality stainless steel (AISI, ASTM and DIN standards, which is imported from Germany, Japan & France). We are committed to producing and serving the best quality instruments. We are devoted to delivering quality products at affordable prices.

### 1 Dental Instruments

Dental instruments are tools that dental professionals use to provide dental treatment. They include tools to examine, manipulate, treat, restore and remove teeth and surrounding oral structures

### 2 Surgical Instruments

A surgical instrument is a tool or device performing specific actions or carrying out desired effects during a surgery or operation, such as modifying biological tissue, or to provide access for viewing it

### 3 Orthopedic Instruments

Orthopedic surgery instruments are designed for surgeries related to muscles, joint, ligaments and bones. Our extensive range of orthopedic instruments accommodates a variety of medical approaches

<b>01</b>	<b>SCALPELS, KNIVES AND SCALPEL HANDLES</b>	<b>01 TO 04</b>
<b>02</b>	<b>SCISSORS</b>	<b>05 TO 21</b>
<b>03</b>	<b>DISSECTING-AND TISSUE FORCEPS</b>	<b>22 TO 32</b>
<b>04</b>	<b>SPONGE DRESSING AND TISSUE GRASPING FORCEPS TOWEL CLAMPS</b>	<b>33 TO 38</b>
<b>05</b>	<b>VESSEL CLIPS BULLDOG CLAMPS HAEMOSTATIC FORCEPS</b>	<b>39 TO 47</b>
<b>06</b>	<b>LIGATURE, HYSTERECTOMY AND COMPRESSION FORCEPS VAGINAL CLAMPS</b>	<b>48 TO 50</b>
<b>07</b>	<b>PROBES APPLICATION, SPATULAS</b>	<b>51 TO 55</b>
<b>08</b>	<b>NEEDLE HOLDERS, SUTURE INSTRUMENTS</b>	<b>56 TO 58</b>
<b>09</b>	<b>WOUND RETRACTORS</b>	<b>59 TO 70</b>
<b>10</b>	<b>SELF RETAINING TTRACTORS ABDOMINAL RETRACTORS</b>	<b>71 TO 75</b>
<b>11</b>	<b>ABDOMINAL SURGERY INTESTINAL- AND RECTAL INSTRUMENTS</b>	<b>76 TO 83</b>
<b>12</b>	<b>GALL BLADDER-, LIVER-AND SPLEEN INSTRUMENTS</b>	<b>84 TO 86</b>
<b>13</b>	<b>GENITO-URINARY INSTRUMENTS AND TROCARS</b>	<b>87 TO 90</b>
<b>14</b>	<b>VAGINAL SPECULA AND UTERINE DILATORS</b>	<b>91 TO 96</b>





1/2

**SIMZ-02-101 - 110**  
Fig. 1 - 10



1/4

**SIMZ-02-101**  
Fig. 1  
30 mm



**SIMZ-02-102**  
Fig. 2  
36 mm



**SIMZ-02-103**  
Fig. 3  
40 mm



**SIMZ-02-104**  
Fig. 4  
45 mm



**SIMZ-02-105**  
Fig. 5  
50 mm



1/4

**SIMZ-02-106**  
Fig. 6  
27 mm



**SIMZ-02-107**  
Fig. 7  
35 mm



**SIMZ-02-108**  
Fig. 8  
40 mm



**SIMZ-02-109**  
Fig. 9  
47 mm



**SIMZ-02-110**  
Fig. 10  
50 mm



Model	Brand	Model	Brand	Model	Brand	Model	Brand	Model	Brand
SIMZ-02-111	LISTON	SIMZ-02-115	CATLIN	SIMZ-02-116	LANGENBECK	SIMZ-02-117	Interosseous Knives	SIMZ-02-118	with raspatory, Wooden handle
SIMZ-02-112	Amputating Knives	SIMZ-02-113	Amputating Knives	SIMZ-02-114	Amputating Knives	SIMZ-02-119	Flap Knives	SIMZ-02-120	Cartilage Knives
SIMZ-02-121	Autopsy Knives								



<b>SIMZ-02-122</b>	<b>SIMZ-02-123</b>	<b>SIMZ-02-124</b>	<b>SIMZ-02-125</b>	<b>SIMZ-02-126</b>	<b>SIMZ-02-127</b>	<b>SIMZ-02-128</b>	<b>SIMZ-02-129</b>
AYRE	Size: 230 mm	SEGOND	OLIVECRONA	Size: 230 mm	FOWLER	ABRAHAM	BRUNINGS
Size: 235 mm	Cone Knife	Size: 270 mm	Size: 205 mm	Trigeminal	Size: 200 mm	Size: 215 mm	Size: 215 mm
Cone Knife		Myomatome	Knife	Knife	Tonsil Knife	Tonsil Knife	Tonsil Knife

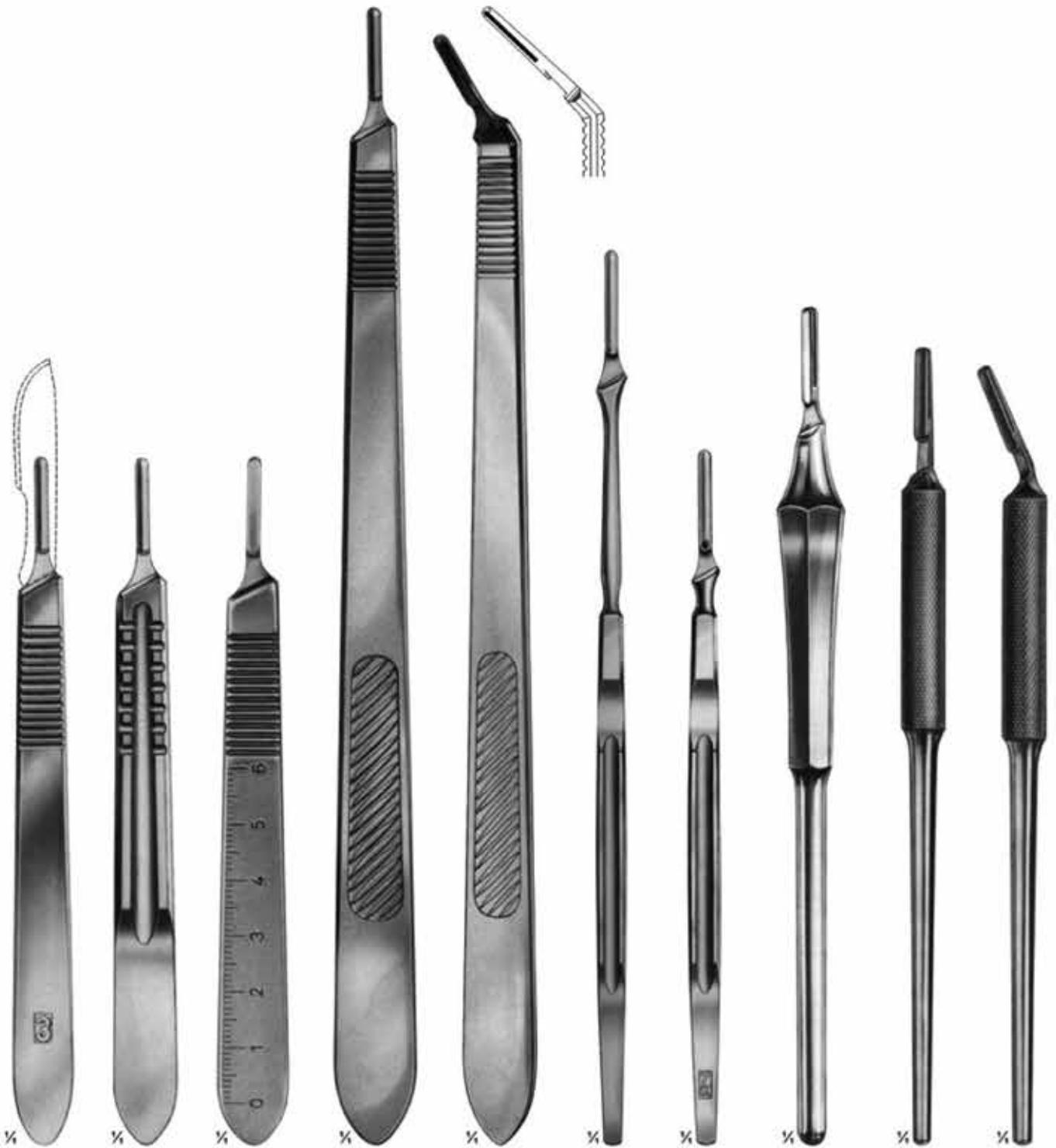

<b>SIMZ-02-130</b>	<b>SIMZ-02-131</b>	<b>SIMZ-02-132</b>	<b>SIMZ-02-133</b>	<b>SIMZ-02-134</b>	<b>SIMZ-02-135</b>	<b>SIMZ-02-136</b>	<b>SIMZ-02-137</b>	<b>SIMZ-02-138</b>	<b>SIMZ-02-139</b>
STANDARD	No. 3	No. 3	No. 3 L	No. 3 L	No. 7	No. 7 K	Hollow-Round	No. 3	No. 3
No. 3	Solid	Solid	Straight	Angled	Solid	Solid	15.5 cm	Straight	Angled
Solid	12 cm	12 cm	Solid	Solid	16 cm	12.5 cm		Solid, Round	Solid, Round
12 cm			21.5 cm	21 cm				14.5 cm	14 cm





**SIMZ-03-101 - 103**  
VANNAS  
Size: 85 mm



**SIMZ-03-104 - 105**  
CASTROVIEJO  
Size: 95 mm



**SIMZ-03-106**  
NOYES  
Size: 125 mm



**SIMZ-03-107 - 108**  
WECKER  
Eye scissor  
Size: 110 mm



**SIMZ-03-109**  
CASTROVIEJO  
Eye scissor  
Size: 115 mm



**SIMZ-03-110 - 111**  
CASTROVIEJO  
Eye scissor  
Size: 110 mm



**SIMZ-03-112 SIMZ-03-113**

**SIMZ-03-112 - 113**  
Size: 120 mm

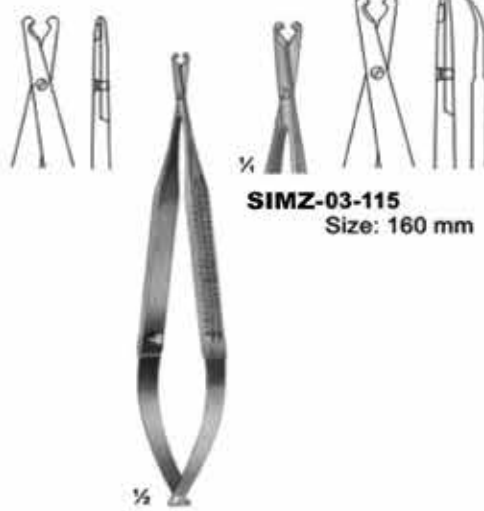

**SIMZ-03-115**  
Size: 160 mm

**SIMZ-03-114**  
BIEMER  
Vein scissor  
Size: 130 mm



**SIMZ-03-116 SIMZ-03-117**

**SIMZ-03-116 - 117**  
VANNAS  
Size: 160 mm

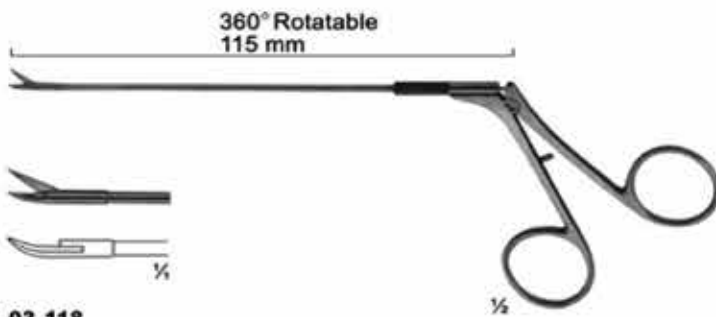

**SIMZ-03-118**  
CASPAR  
Micro scissor curved  
Size: 115 mm

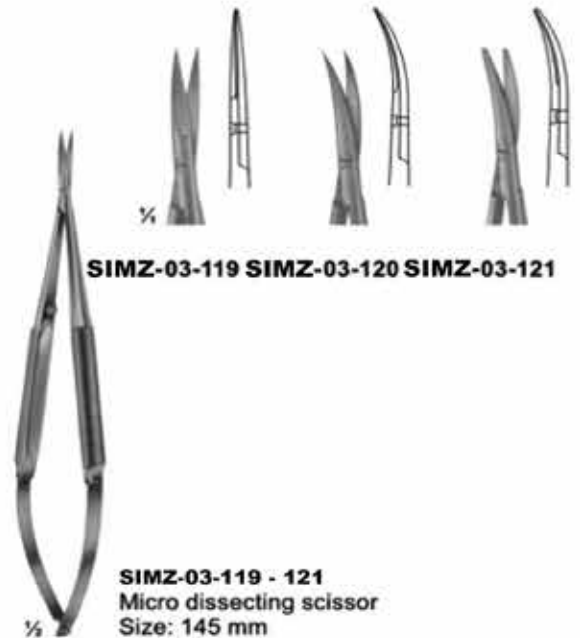

**SIMZ-03-119 SIMZ-03-120 SIMZ-03-121**

**SIMZ-03-119 - 121**  
Micro dissecting scissor  
Size: 145 mm



**SIMZ-03-122**  
YASARGIL  
Size: 245 mm



**SIMZ-03-123 - 124**  
laterally angled  
Size: 200 mm



**SIMZ-03-125**  
laterally angled  
Size: 190 mm



**SIMZ-03-126 - 127**  
YASARGIL  
Size: 225 mm

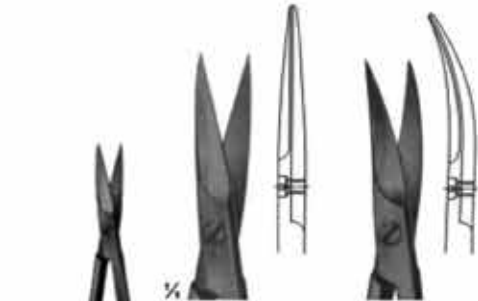

**SIMZ-03-128 SIMZ-03-129**

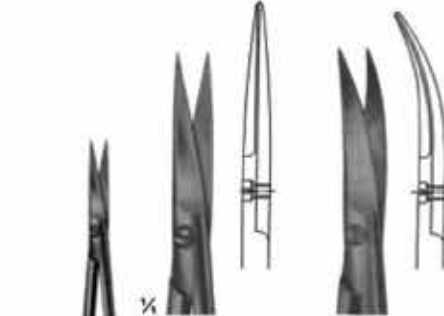

**SIMZ-03-130 SIMZ-03-131**



**SIMZ-03-132 SIMZ-03-133**

**SIMZ-03-128 - 129**  
Size: 90 mm

**SIMZ-03-130 - 131**  
Size: 95 mm

**SIMZ-03-132 - 133**  
Size: 105 mm

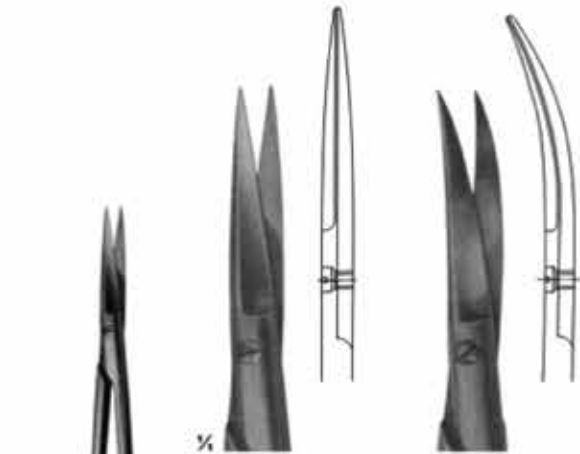

**SIMZ-03-134**

**SIMZ-03-135**

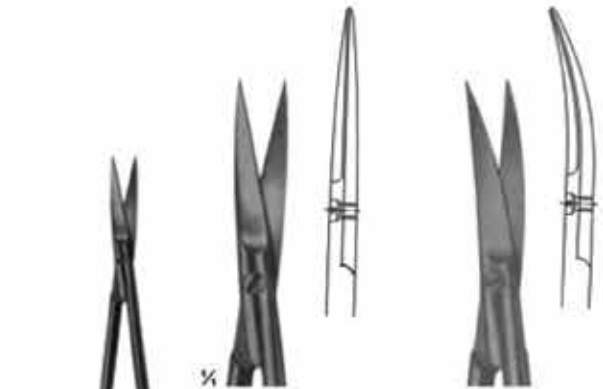

**SIMZ-03-136**

**SIMZ-03-137**

**SIMZ-03-134 - 135**  
Size: 120 mm

**SIMZ-03-136 - 137**  
Size: 115 mm



**SIMZ-03-138 - 140**  
Size: 120 mm



**SIMZ-03-138**



**SIMZ-03-139**



**SIMZ-03-140**



**SIMZ-03-141 - 144**  
Size: 130 mm



**SIMZ-03-141**



**SIMZ-03-142**



**SIMZ-03-143**



**SIMZ-03-144**



**SIMZ-03-145 - 153 (Standard types)**  
**SIMZ-03-145** ( 105 mm )  
**SIMZ-03-146** ( 115 mm )  
**SIMZ-03-147** ( 130 mm )  
**SIMZ-03-148** ( 145 mm )  
**SIMZ-03-149** ( 150 mm )  
**SIMZ-03-150** ( 165 mm )  
**SIMZ-03-151** ( 175 mm )  
**SIMZ-03-152** ( 185 mm )  
**SIMZ-03-153** ( 200 mm )



**SIMZ-03-154 - 160 (Standard types)**  
**SIMZ-03-154** ( 115 mm )  
**SIMZ-03-155** ( 130 mm )  
**SIMZ-03-156** ( 145 mm )  
**SIMZ-03-157** ( 150 mm )  
**SIMZ-03-158** ( 165 mm )  
**SIMZ-03-159** ( 175 mm )  
**SIMZ-03-160** ( 185 mm )

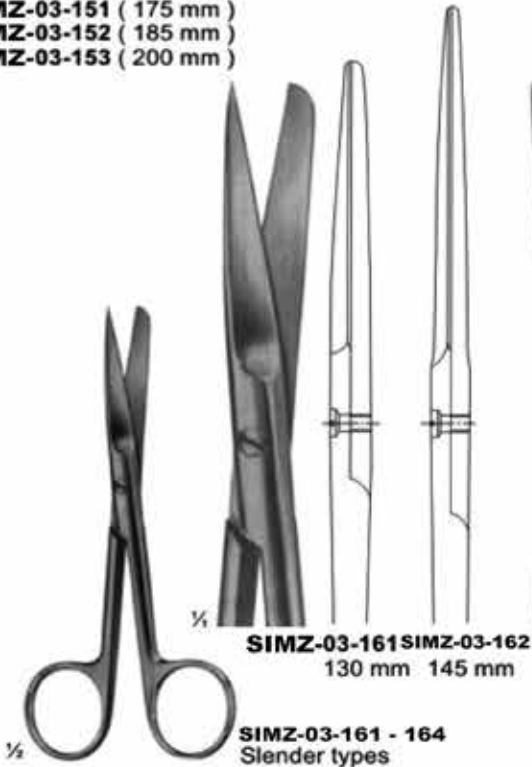

**SIMZ-03-161** 130 mm  
**SIMZ-03-162** 145 mm

**SIMZ-03-161 - 164**  
 Slender types



**SIMZ-03-163** 130 mm  
**SIMZ-03-164** 145 mm

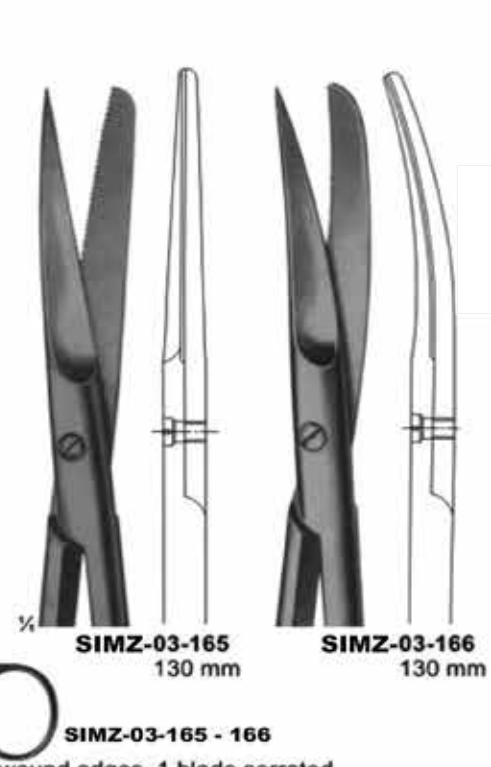

**SIMZ-03-165** 130 mm

**SIMZ-03-166** 130 mm

**SIMZ-03-165 - 166**  
 for wound edges. 1 blade serrated

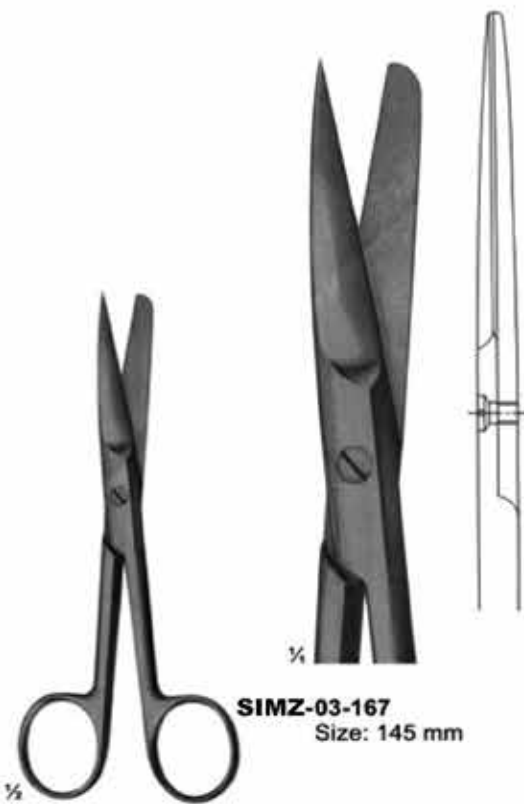

**SIMZ-03-167**  
Size: 145 mm

**SIMZ-03-168**  
Size: 145 mm

**SIMZ-03-169**  
Size: 145 mm

**SIMZ-03-167 - 169**  
DEAVER  
with flat lock



**SIMZ-03-170** Size: 130 mm  
**SIMZ-03-171** Size: 145 mm  
**SIMZ-03-172** Size: 165 mm

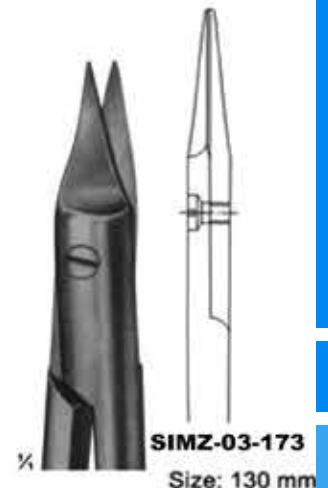

**SIMZ-03-173**  
Size: 130 mm

**SIMZ-03-170 - 172**  
Incision scissors

**SIMZ-03-173**  
SYSTRUNK  
Nail splitting scissors

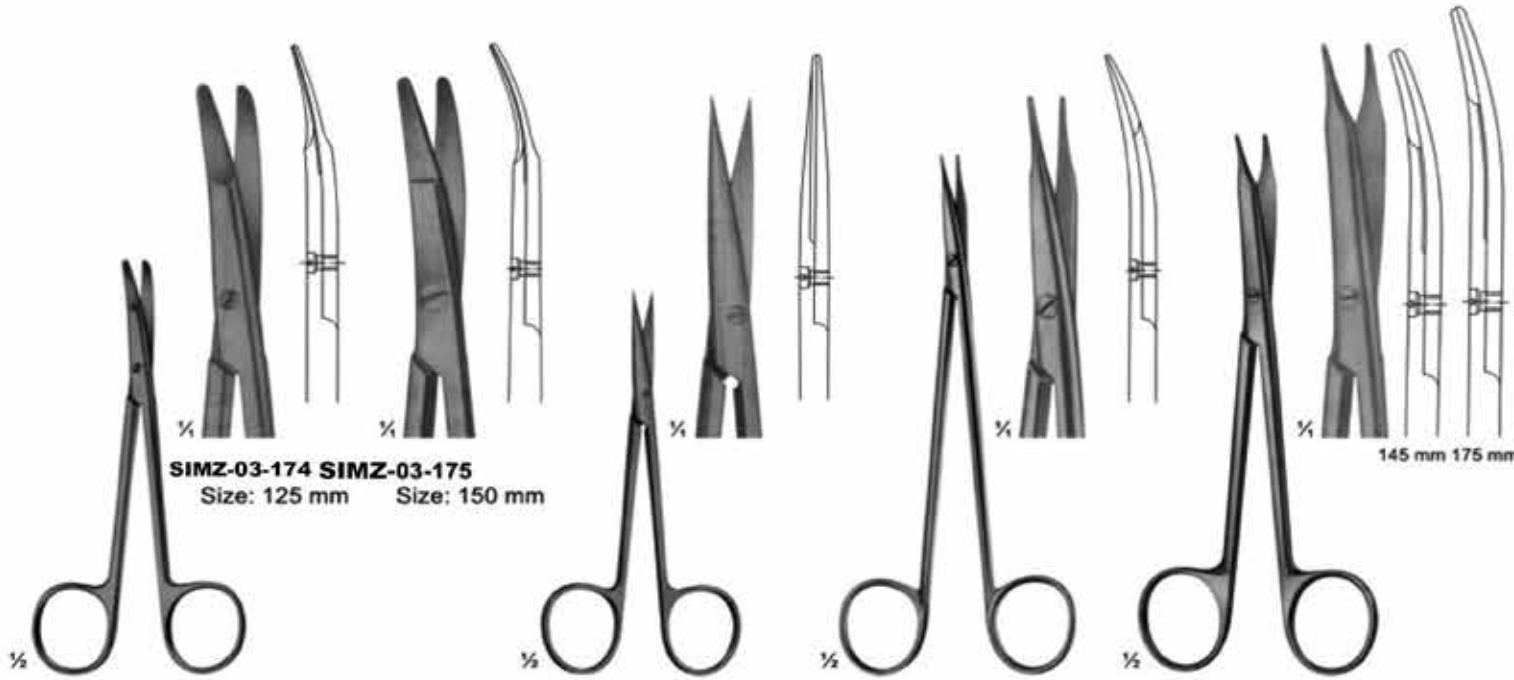

**SIMZ-03-174 SIMZ-03-175**  
Size: 125 mm    Size: 150 mm

**SIMZ-03-174 - 175**  
**KILNER**  
Special flat points for dissecting and undermining the skin

**SIMZ-03-176**  
**KILNER**  
Fine dissecting scissors  
Size: 115 mm

**SIMZ-03-177**  
**JAMESON**  
Dissecting scissors  
Size: 150 mm

**SIMZ-03-178**  
**REYNOLDS**  
Dissecting scissors  
Size: 145 - 175 mm

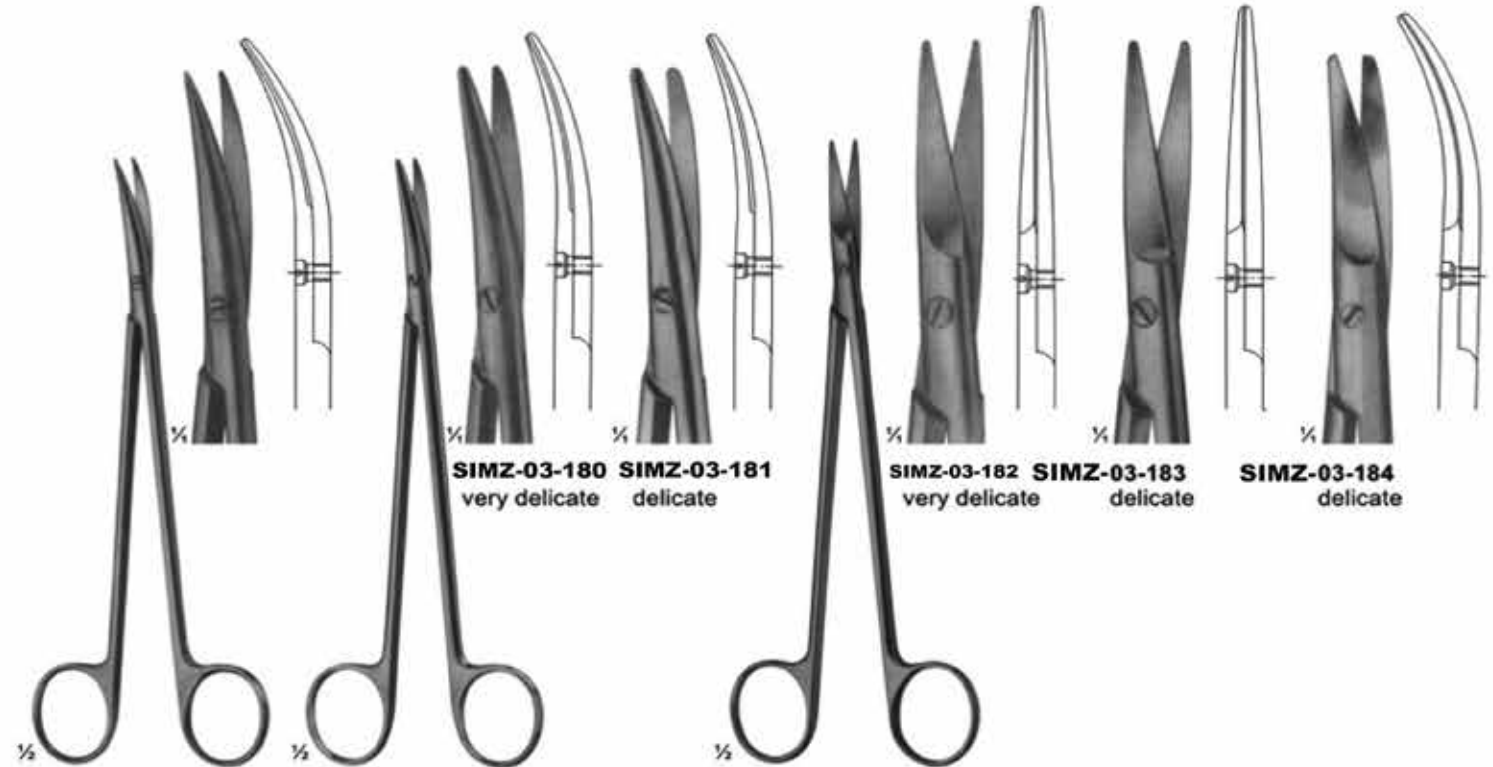

**SIMZ-03-180 SIMZ-03-181**  
very delicate    delicate

**SIMZ-03-182 SIMZ-03-183**  
very delicate    delicate

**SIMZ-03-184**  
delicate

**SIMZ-03-179**  
**DE BAKEY**  
Arteriotomy scissors  
Size: 175 mm

**SIMZ-03-180 - 181**  
**TOENNIS ADSON**  
Dissecting scissors  
Size: 175 mm

**SIMZ-03-182 - 184**  
**TOENNIS**  
Dissecting scissors  
Size: 180 mm





**SIMZ-03-185 - 186**  
MAYO-STILLE  
with chamfered blades  
**SIMZ-03-185** (140 mm)  
**SIMZ-03-186** (170 mm)

**MAYO-STILLE**  
**SIMZ-03-187** (140 mm)  
**SIMZ-03-188** (170 mm)

**MAYO**  
with chamfered blades  
**SIMZ-03-189** (190 mm)  
**SIMZ-03-190** (215 mm)

**MAYO**  
**SIMZ-03-191**  
Size: 190 mm  
**SIMZ-03-192**  
Size: 215 mm

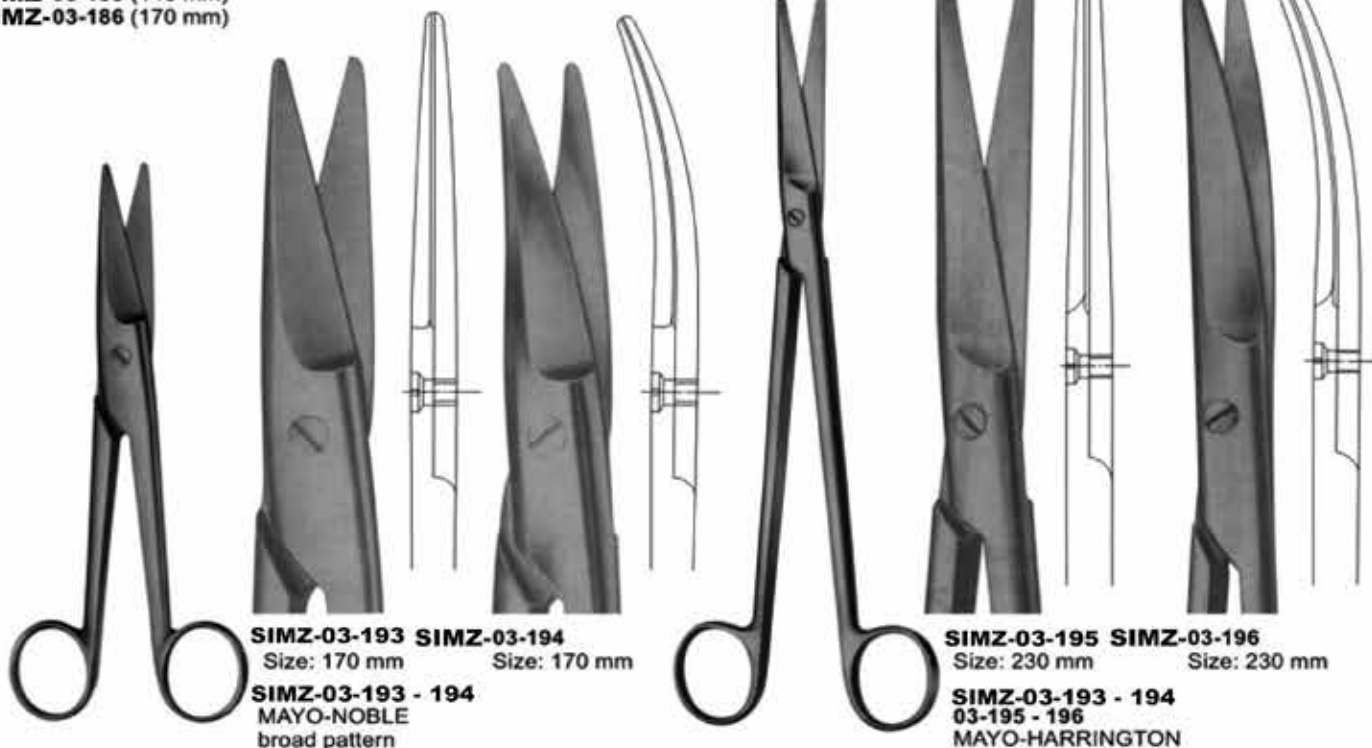

**SIMZ-03-193** Size: 170 mm  
**SIMZ-03-194** Size: 170 mm  
**SIMZ-03-193 - 194**  
MAYO-NOBLE  
broad pattern

**SIMZ-03-195** Size: 230 mm  
**SIMZ-03-196** Size: 230 mm  
**SIMZ-03-193 - 194**  
03-195 - 196  
MAYO-HARRINGTON



**SIMZ-03-197**  
OLIVECRONA  
Dura scissors



**SIMZ-03-198**  
STRULLY  
pointed  
Size: 220 mm

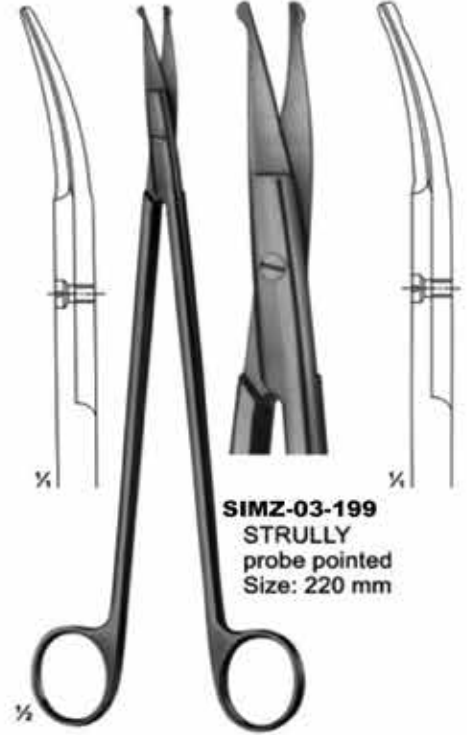

**SIMZ-03-199**  
STRULLY  
probe pointed  
Size: 220 mm

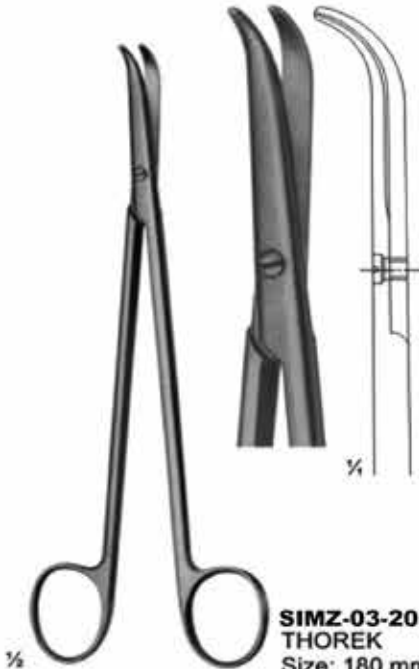

**SIMZ-03-200**  
THOREK  
Size: 180 mm

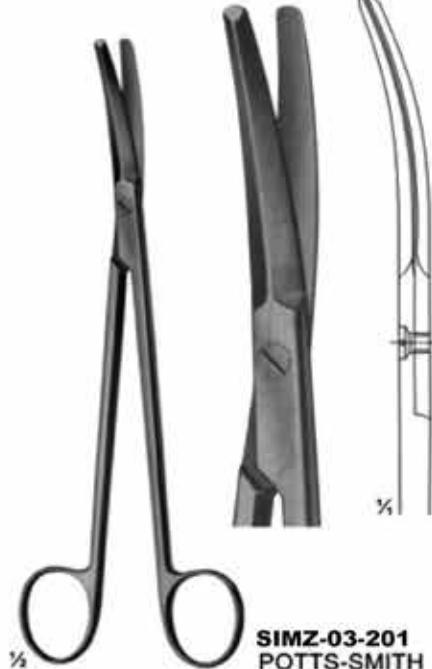

**SIMZ-03-201**  
POTTS-SMITH  
Size: 190 mm

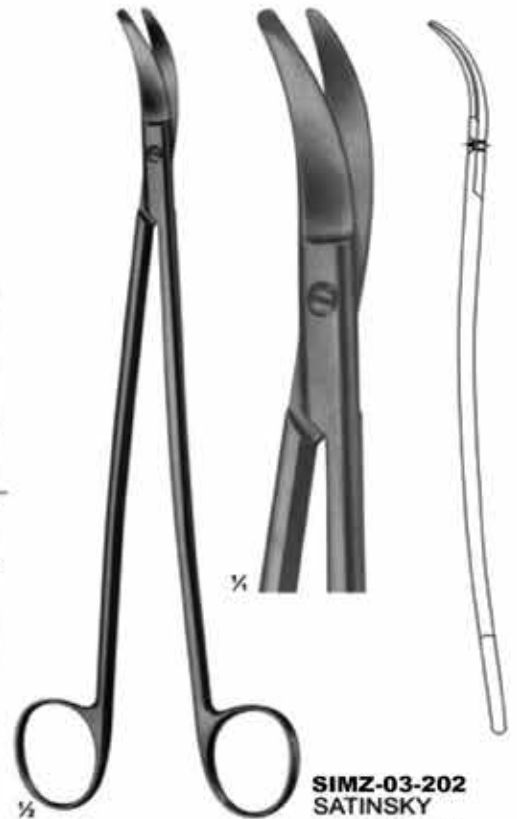

**SIMZ-03-202**  
SATINSKY  
Size: 245 mm



**SIMZ-03-203**  
1 finely toothed blade  
Size: 130 mm

**SIMZ-03-204**  
LOCKLIN  
curved sideways,  
1 toothed blade  
Size: 155 mm



**SIMZ-03-205**  
FOMON  
blades serrated  
Size: 145 mm

**SIMZ-03-206**  
COTTLE  
Size: 165 mm



**SIMZ-03-207**  
HEYMANN-KNIGHT  
Size: 175 mm

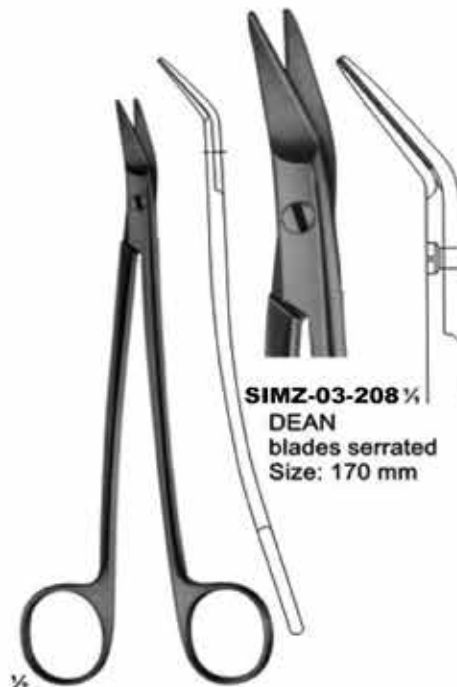

**SIMZ-03-208** 1/2  
DEAN  
blades serrated  
Size: 170 mm

**SIMZ-03-209**  
GOOD  
Size: 195 mm

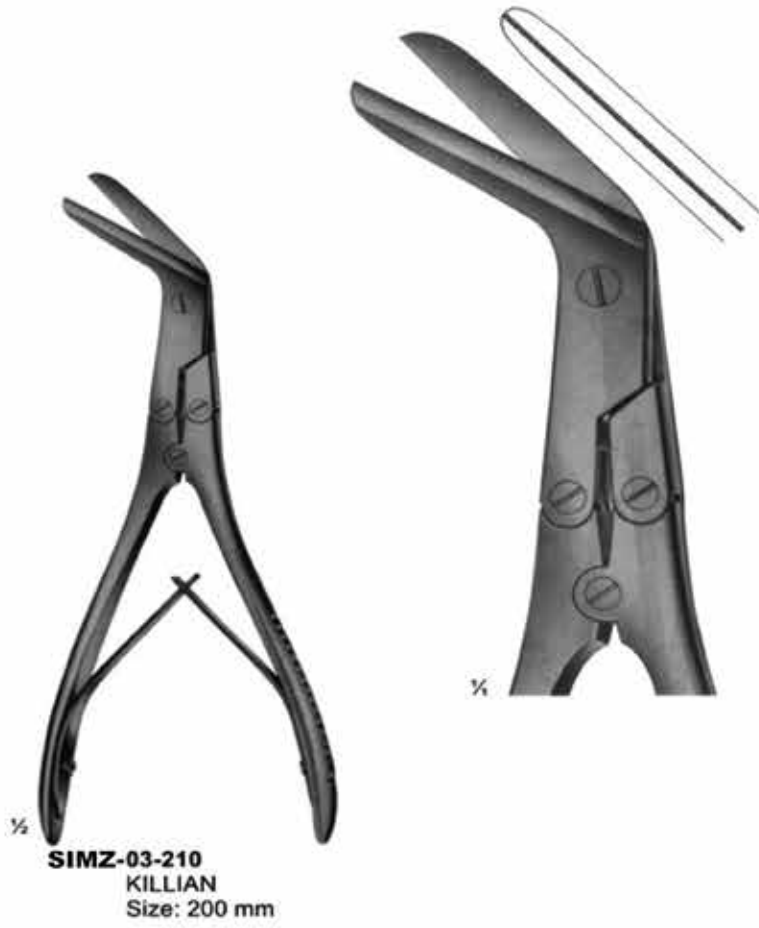

**SIMZ-03-211 - 03-212**



**SIMZ-03-211**  
195 mm



**SIMZ-03-212**  
225 mm



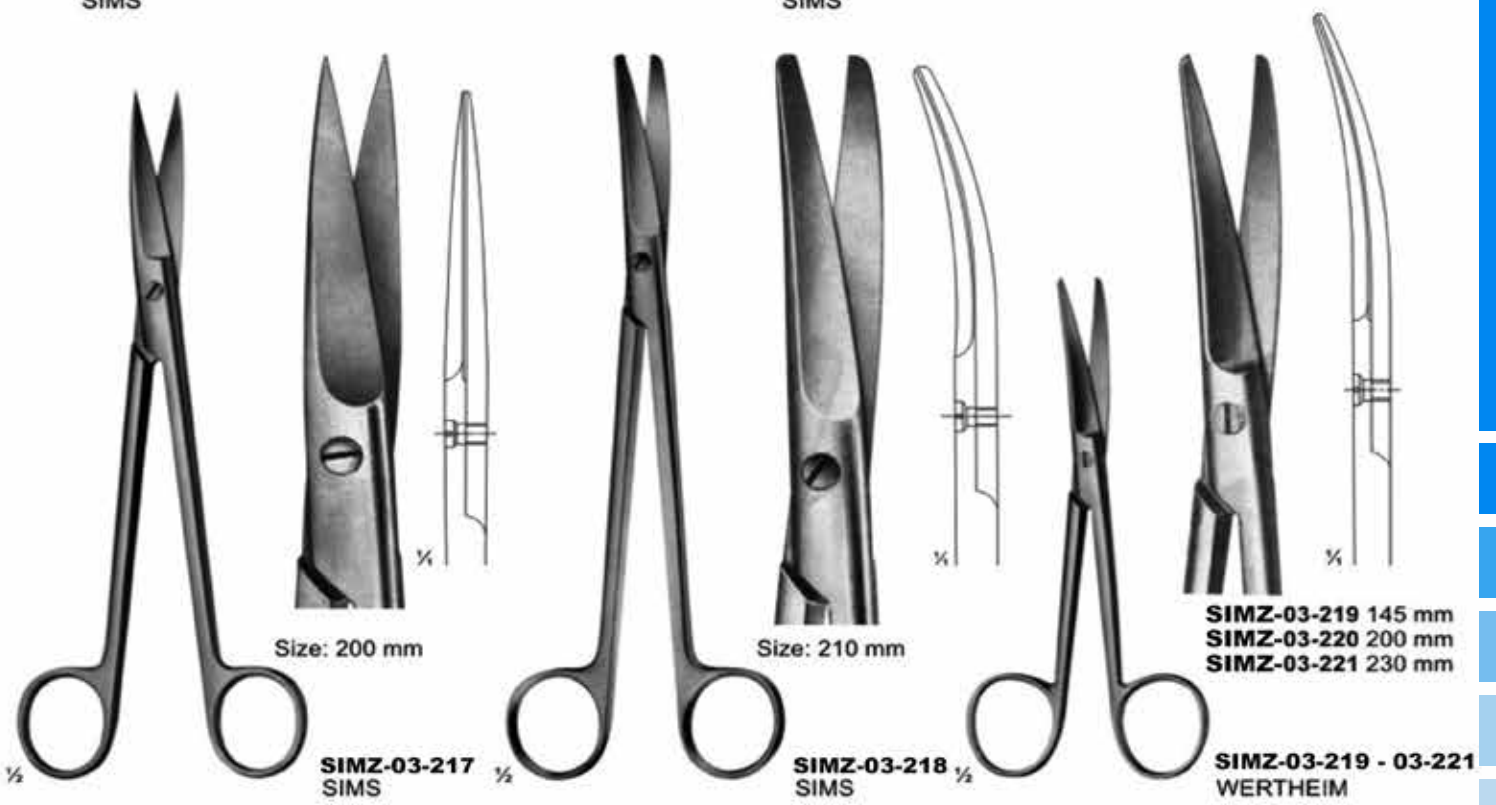
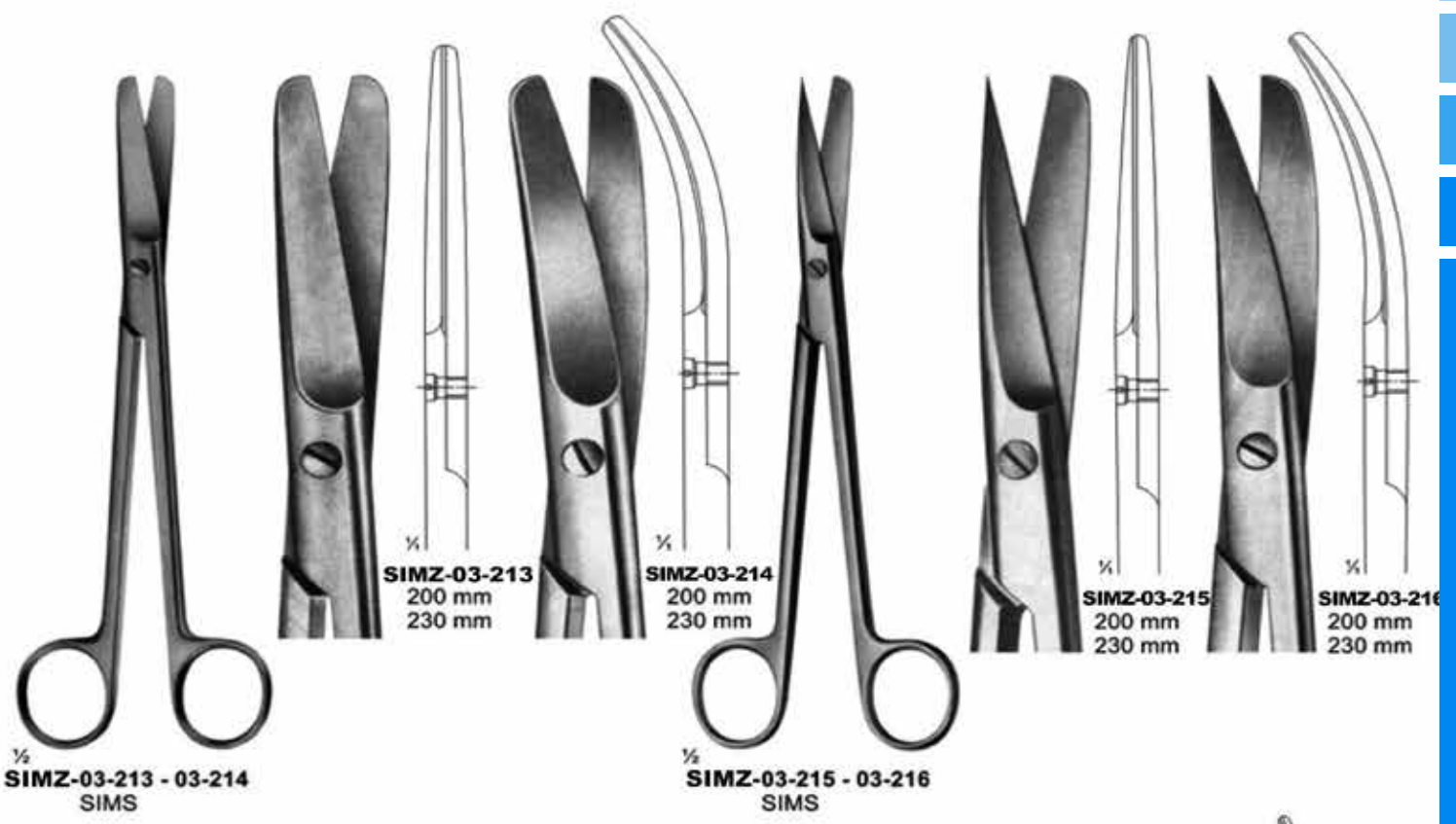



**SIMZ-03-222**  
SCHUMACHER  
Umbilical cord scissors  
Size: 155 mm



**SIMZ-03-223**  
Umbilical cord scissors  
Size: 105 mm

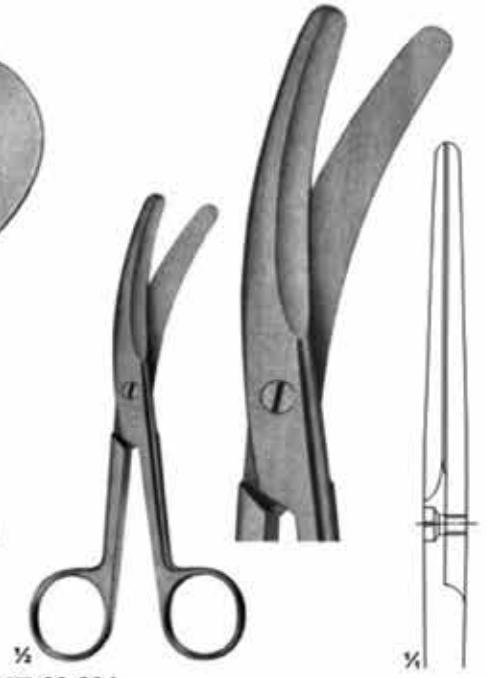

**SIMZ-03-224**  
Umbilical cord scissors  
135 mm



**SIMZ-03-225**  
145 mm



**SIMZ-03-226**  
200 mm



**SIMZ-03-227**  
Episiotomy scissors  
240 mm

**SIMZ-03-225 - 03-226**  
BRAUN-STADLER  
Episiotomy scissors



**SIMZ-03-228 - 03-232**  
BEEBE  
Size: 110 mm



**SIMZ-03-228 SIMZ-03-229 SIMZ-03-230**  
broad blades



**SIMZ-03-231**  
1 blade serrated



**SIMZ-03-232**  
NAUJOKS  
strongly curved



**SIMZ-03-233**  
1 blade serrated  
Size: 120 mm



**SIMZ-03-234**  
STRACK  
Size: 100 mm



**SIMZ-03-235**  
HARVEY  
blades serrated  
Size: 125 mm



**SIMZ-03-236**  
 Universal bandage and cloth scissors,  
 with toothed edges  
 180 mm



**SIMZ-03-237**  
 LISTER  
 Universal bandage and cloth scissors,  
 with toothed edges  
 Size: 145 mm

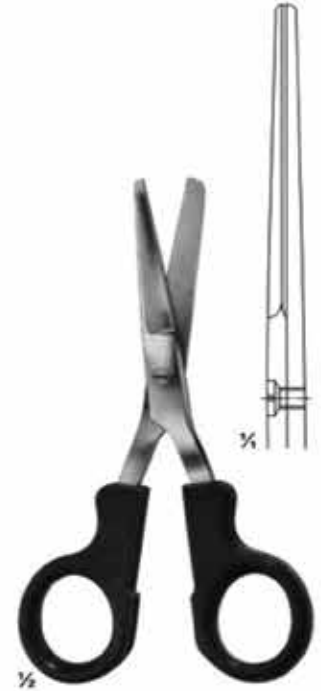

**SIMZ-03-238**  
 LISTER  
 Nurse's scissors  
 Size: 145 mm

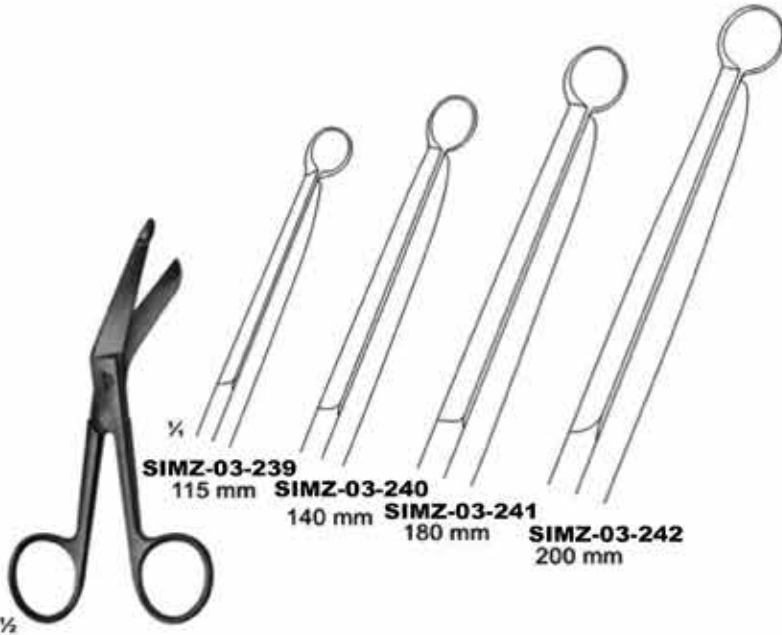

**SIMZ-03-239 - 03-242**  
 LISTER



**SIMZ-03-243 - 03-244**  
 LISTER





**SIMZ-03-245**  
CLOTH SCISSORS  
205 mm



**SIMZ-03-246**  
BRAUN-STADLER  
225 mm



**SIMZ-03-247**  
SEUTIN  
230 mm



**SIMZ-03-248** **SIMZ-03-249**  
200 mm 230 mm

**SIMZ-03-248** **SIMZ-03-249**  
ESMARCH

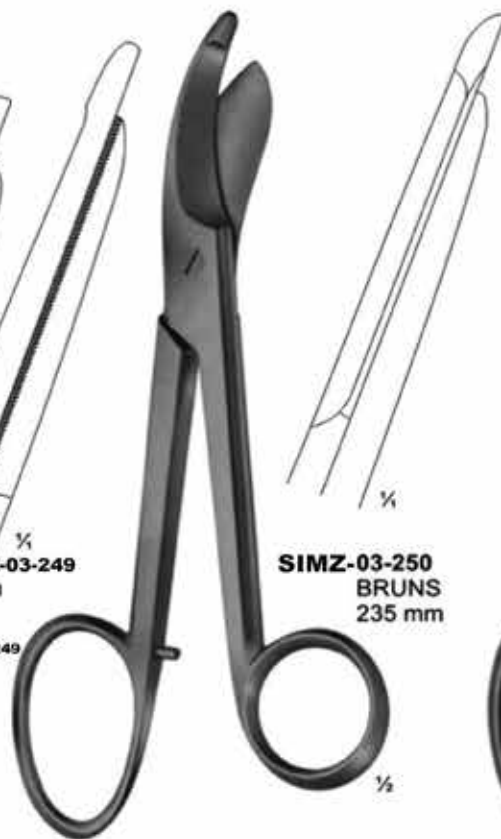

**SIMZ-03-250**  
BRUNS  
235 mm



**SIMZ-03-251**  
Bandage Scissors  
235 mm

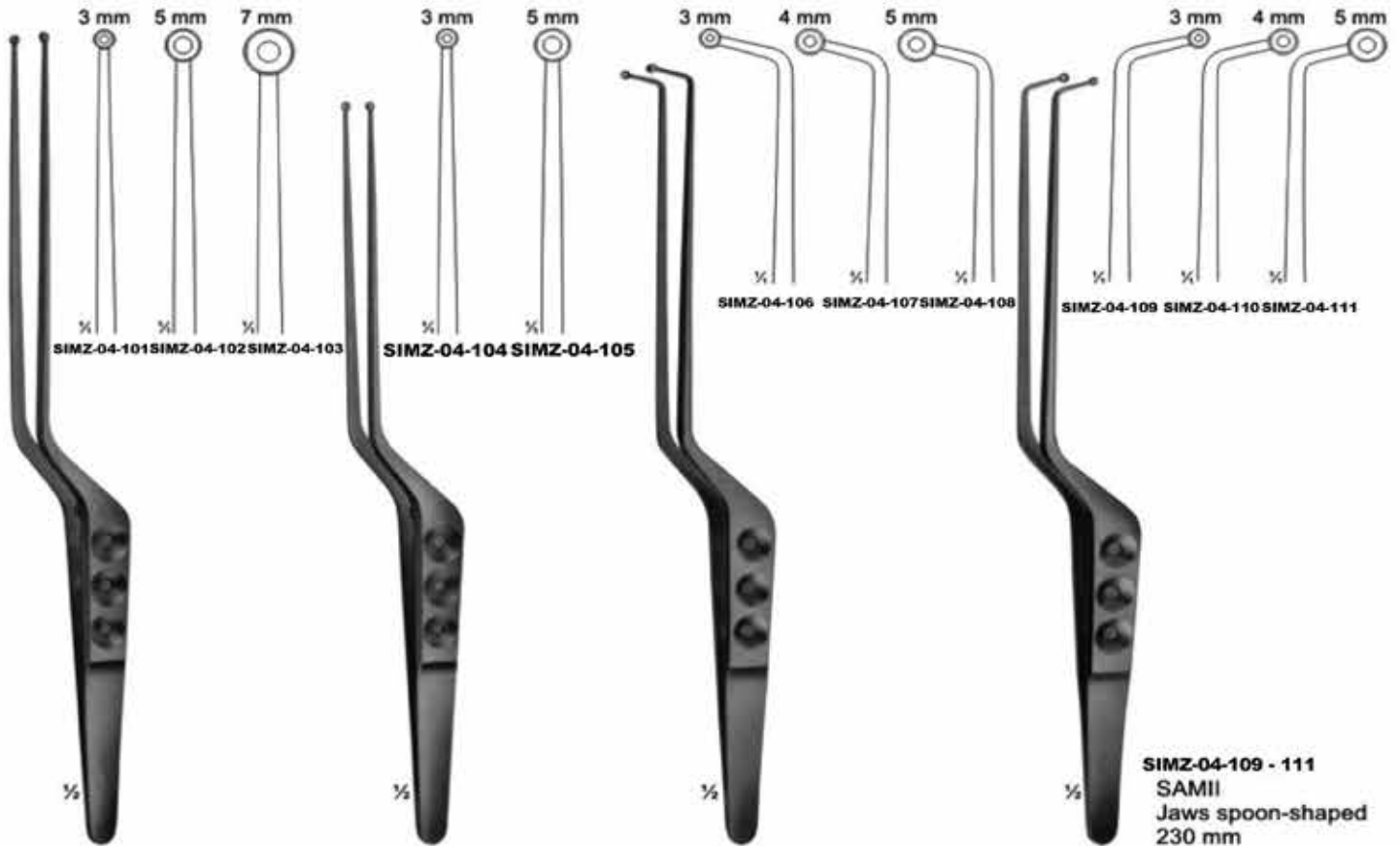

**SIMZ-04-101 - 103**  
YASARGIL-SAMII  
Jaws spoon-shaped  
240 mm

**SIMZ-04-104 - 105**  
YASARGIL  
Jaws spoon-shaped  
220 mm

**SIMZ-04-106 - 108**  
SAMII  
Jaws spoon-shaped  
230 mm

**SIMZ-04-109 - 111**  
SAMII  
Jaws spoon-shaped  
230 mm

**MZ-04-112**  
HUNT  
Tumor-and  
vessel forceps  
200 mm

**SIMZ-04-113**  
HUNT  
Tumor-and  
vessel forceps  
200 mm

**SIMZ-04-114**  
YASARGIL  
Tumor-and  
vessel forceps  
200 mm



**SIMZ-04-115**  
THORPE  
Corneal forceps  
120 mm



**SIMZ-04-116**  
MICRO-ADSON  
120 mm

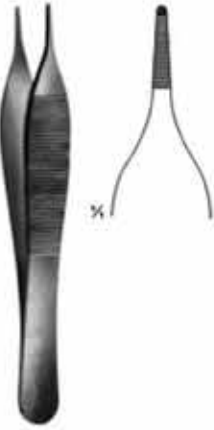

**SIMZ-04-117**  
ADSON  
120 mm



**SIMZ-04-118**  
MICRO-ADSON  
150 mm



**SIMZ-04-119 - 121**  
100 mm

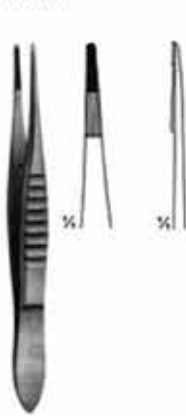

**SIMZ-04-122**  
BONACCOLTO  
110 mm

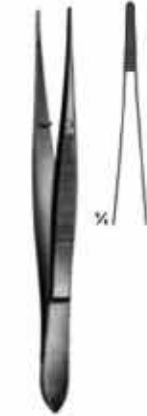

**SIMZ-04-123**  
115 mm

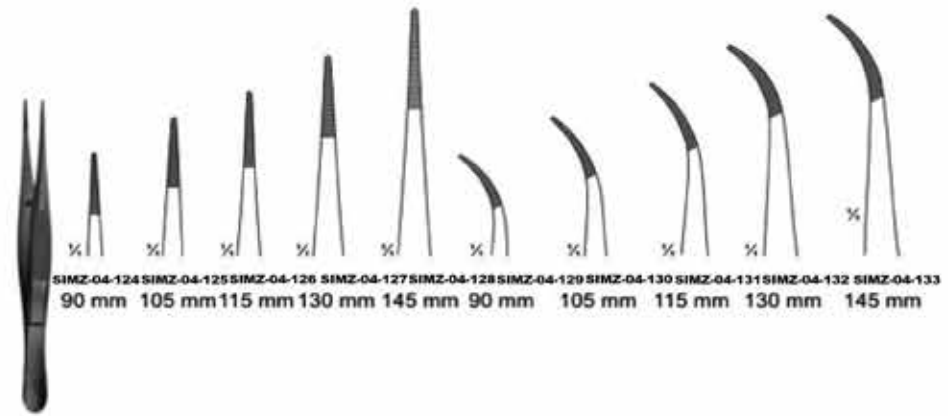

**SIMZ-04-124 - 133**

SIMZ-04-124 90 mm SIMZ-04-125 105 mm SIMZ-04-126 115 mm SIMZ-04-127 130 mm SIMZ-04-128 145 mm SIMZ-04-129 90 mm SIMZ-04-130 105 mm SIMZ-04-131 115 mm SIMZ-04-132 130 mm SIMZ-04-133 145 mm



**SIMZ-04-134**  
100 mm



**SIMZ-04-135**  
100 mm



**SIMZ-04-136**  
100 mm



**SIMZ-04-137**  
KUHNE  
Cover glass forceps, 105 mm



**SIMZ-04-138**  
160 mm

# Delicate Dissecting Forceps

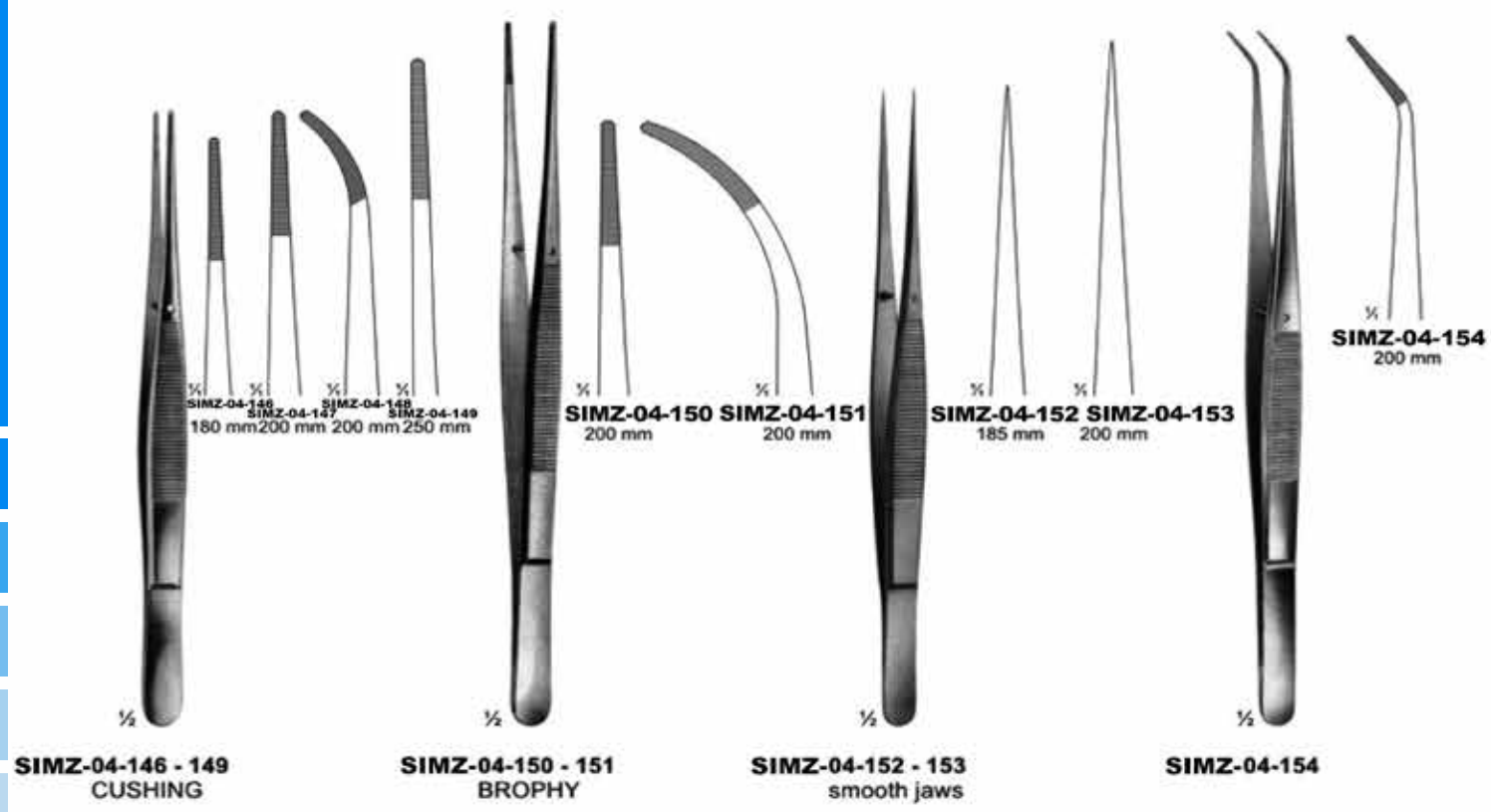
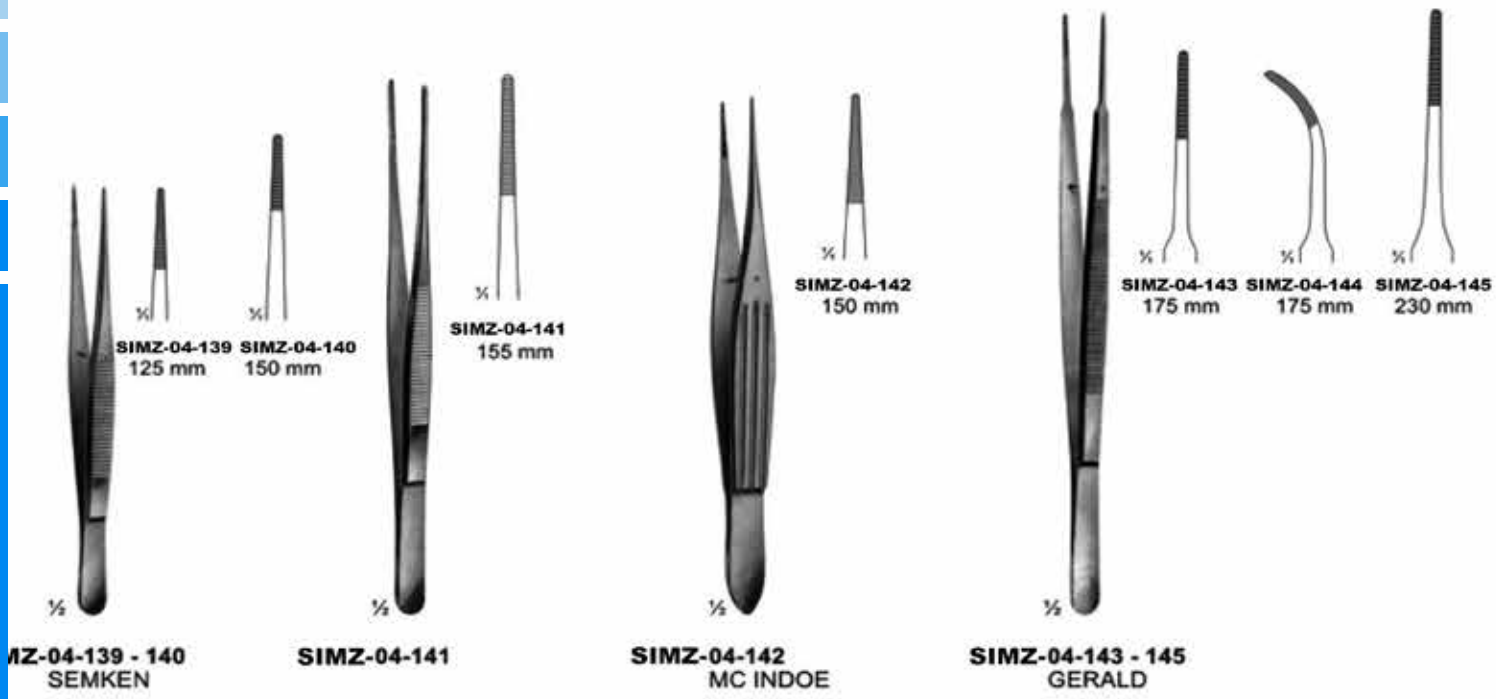

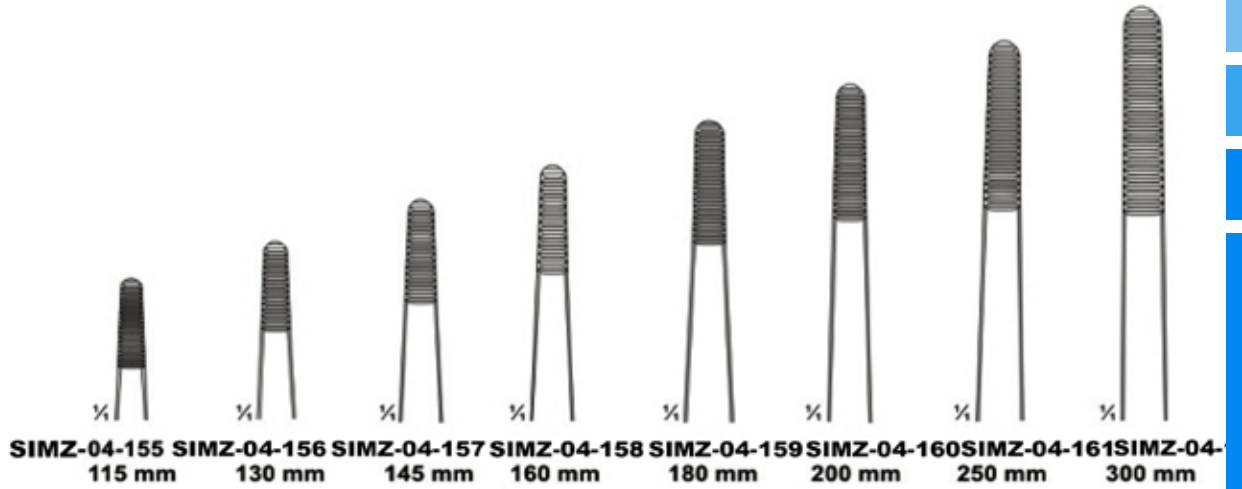

**SIMZ-04-155** 115 mm   **SIMZ-04-156** 130 mm   **SIMZ-04-157** 145 mm   **SIMZ-04-158** 160 mm   **SIMZ-04-159** 180 mm   **SIMZ-04-160** 200 mm   **SIMZ-04-161** 250 mm   **SIMZ-04-162** 300 mm

**SIMZ-04-155 - 04-162**  
STANDARD



**SIMZ-04-163** 115 mm   **SIMZ-04-164** 130 mm   **SIMZ-04-165** 145 mm   **SIMZ-04-166** 160 mm   **SIMZ-04-167** 305 mm

**SIMZ-04-163 - 04-167**  
MEDIUM



**SIMZ-04-168** 130 mm   **SIMZ-04-169** 145 mm

**SIMZ-04-168 - 04-169**  
MEDIUM

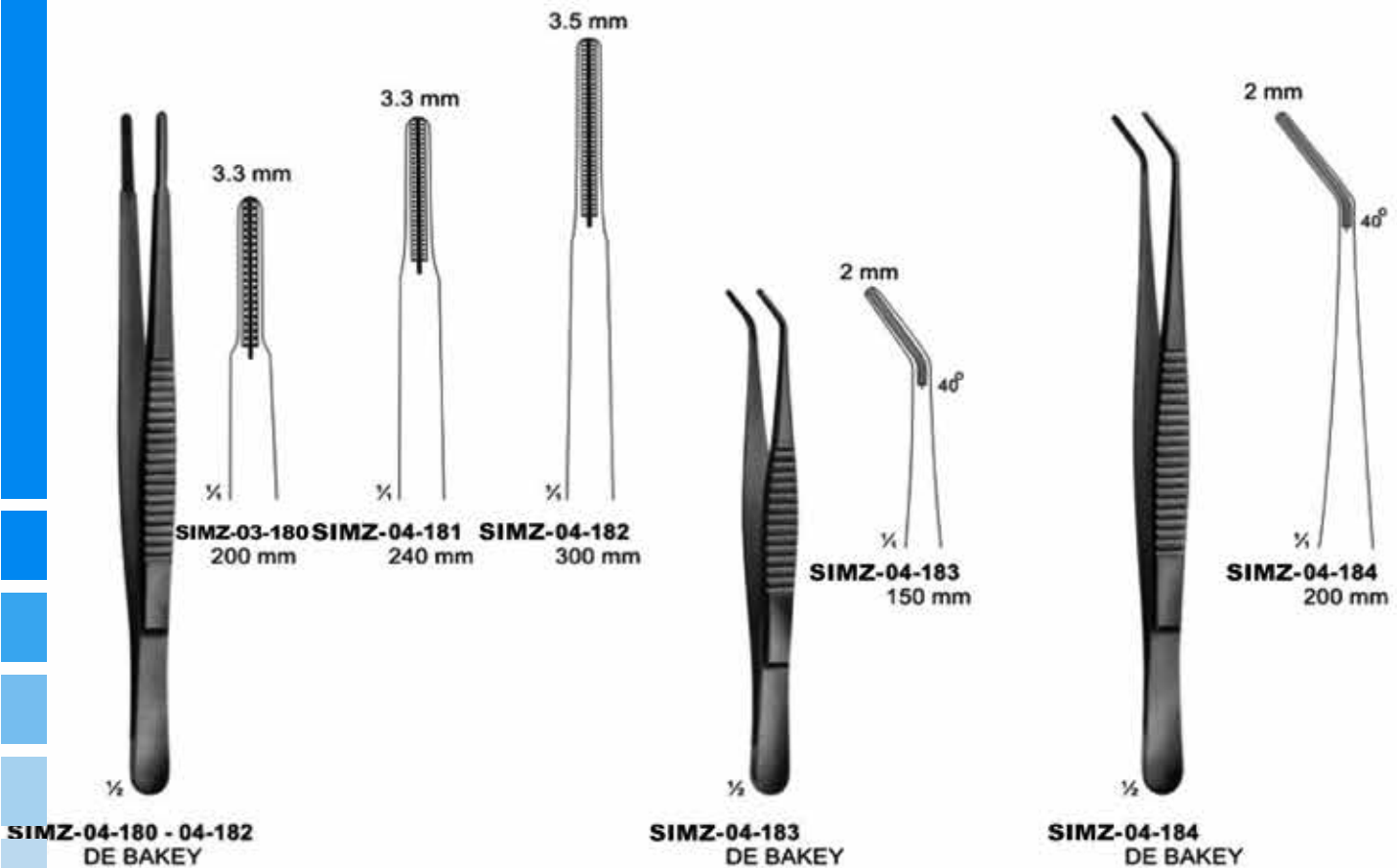
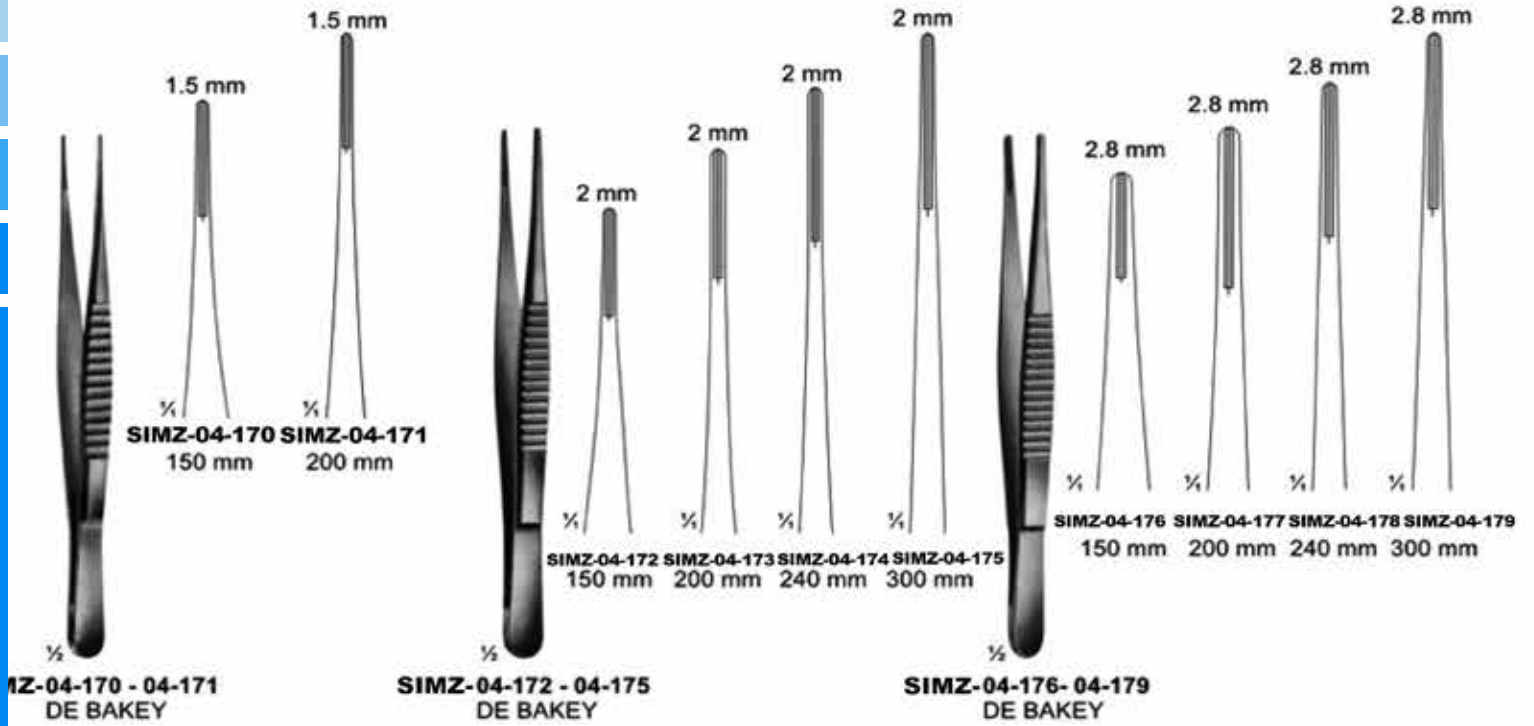



**SIMZ-04-185**  
BISHOP-HARMON  
85 mm

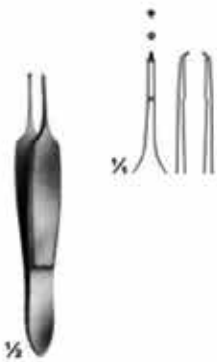

**SIMZ-04-186**  
ST.MARTIN  
80 mm

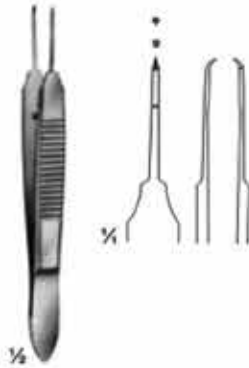

**SIMZ-04-187**  
CASTROVIEJO  
teeth 0.9 mm  
100 mm



**SIMZ-04-188**  
CASTROVIEJO  
teeth 0.5 mm  
100 mm

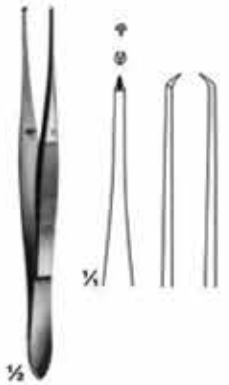

**SIMZ-04-189**  
ELSCHING  
110 mm



**SIMZ-04-190**  
GILL  
75 mm



**SIMZ-04-191**  
GILL - HESS  
75 mm

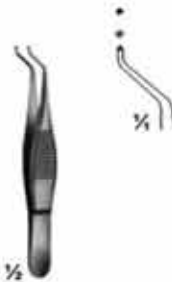

**SIMZ-04-192**  
HESS  
70 mm

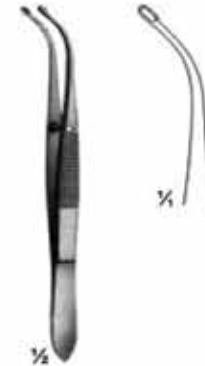

**SIMZ-04-193**  
ARRUGA  
100 mm

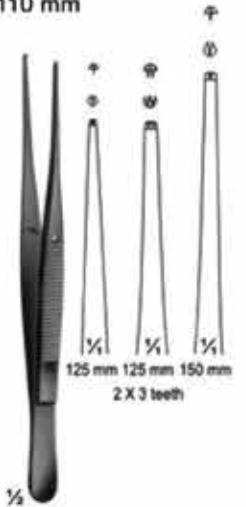

**SIMZ-04-194**  
SEMKEN  
125 mm 125 mm 150 mm  
2 X 3 teeth

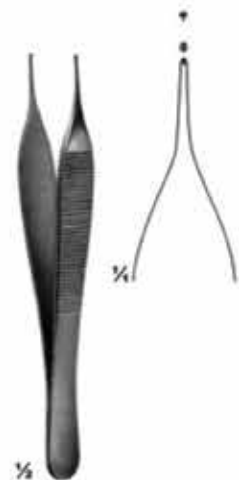

**SIMZ-04-195**  
MICRO-ADSON  
120 mm



**SIMZ-04-196**  
ADSON  
120 mm



**SIMZ-04-197**  
ADSON  
120 mm



**SIMZ-04-198**  
ADSON  
120 mm



**SIMZ-04-199**  
ADSON  
150 mm

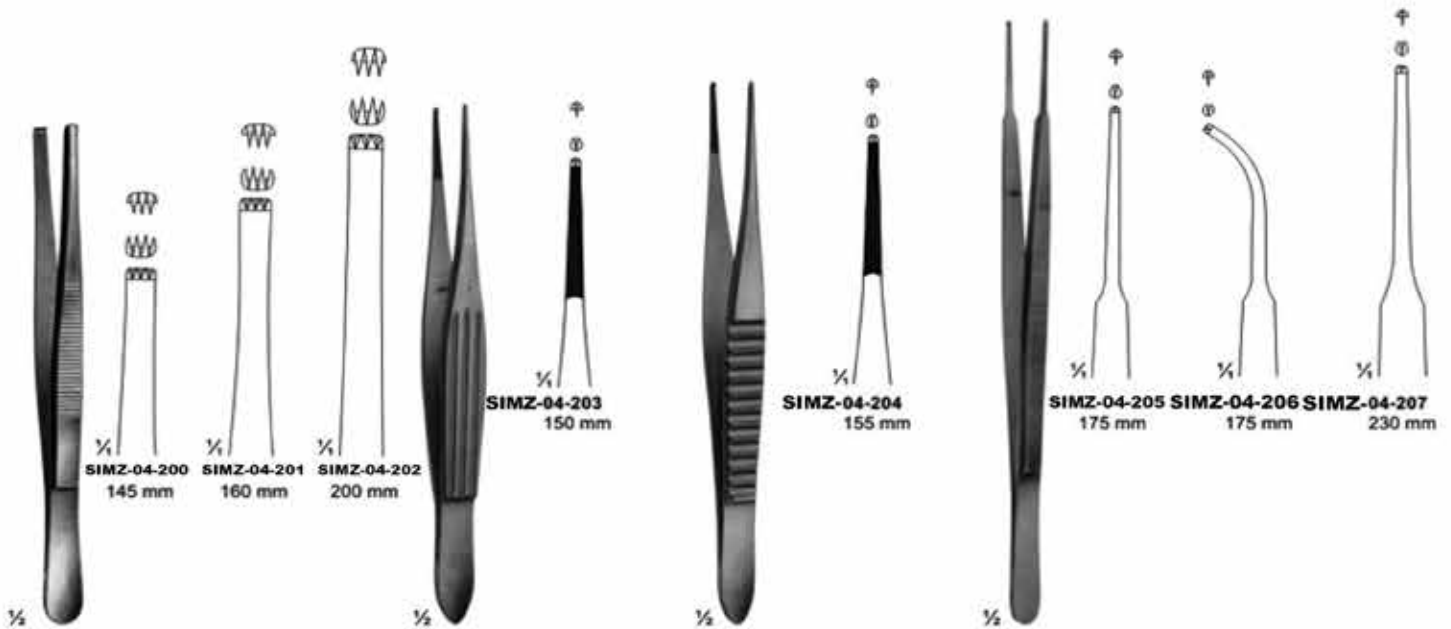

**SIMZ-04-200 - 04-203**  
3x4 teeth

**SIMZ-04-203**  
MC INDOE

**SIMZ-04-204**  
GILLIES

**SIMZ-04-205 - 04-207**  
GERALD

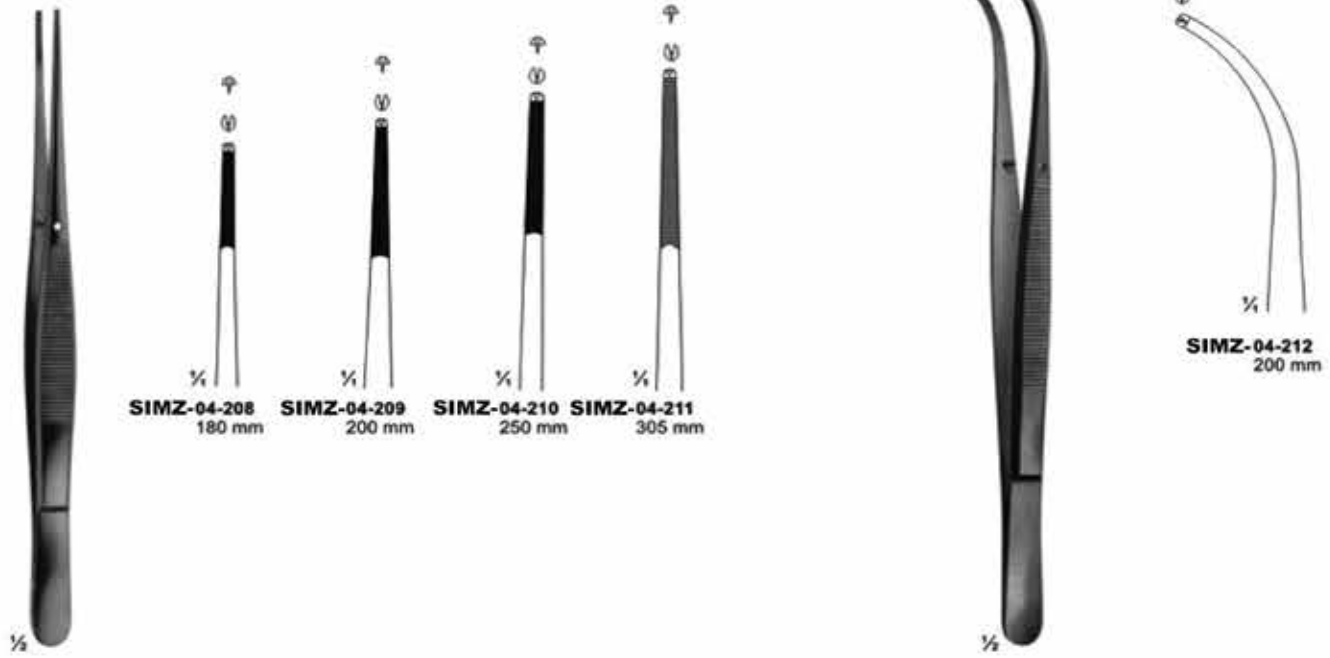

**SIMZ-04-208 - 04-211**  
WAUGH

**SIMZ-04-212**  
BROPHY





**SIMZ-04-213**  
**ADSON - BROWN**  
 Non-traumatic  
 120 mm

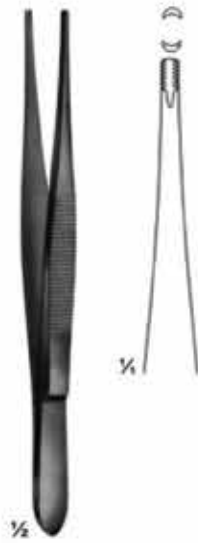

**SIMZ-04-214**  
**BROWN**  
 120 mm



**SIMZ-04-215**  
**GRAEFE**  
 110 mm



**SIMZ-04-216**  
**GRAEFE**  
 With Catch  
 110 mm

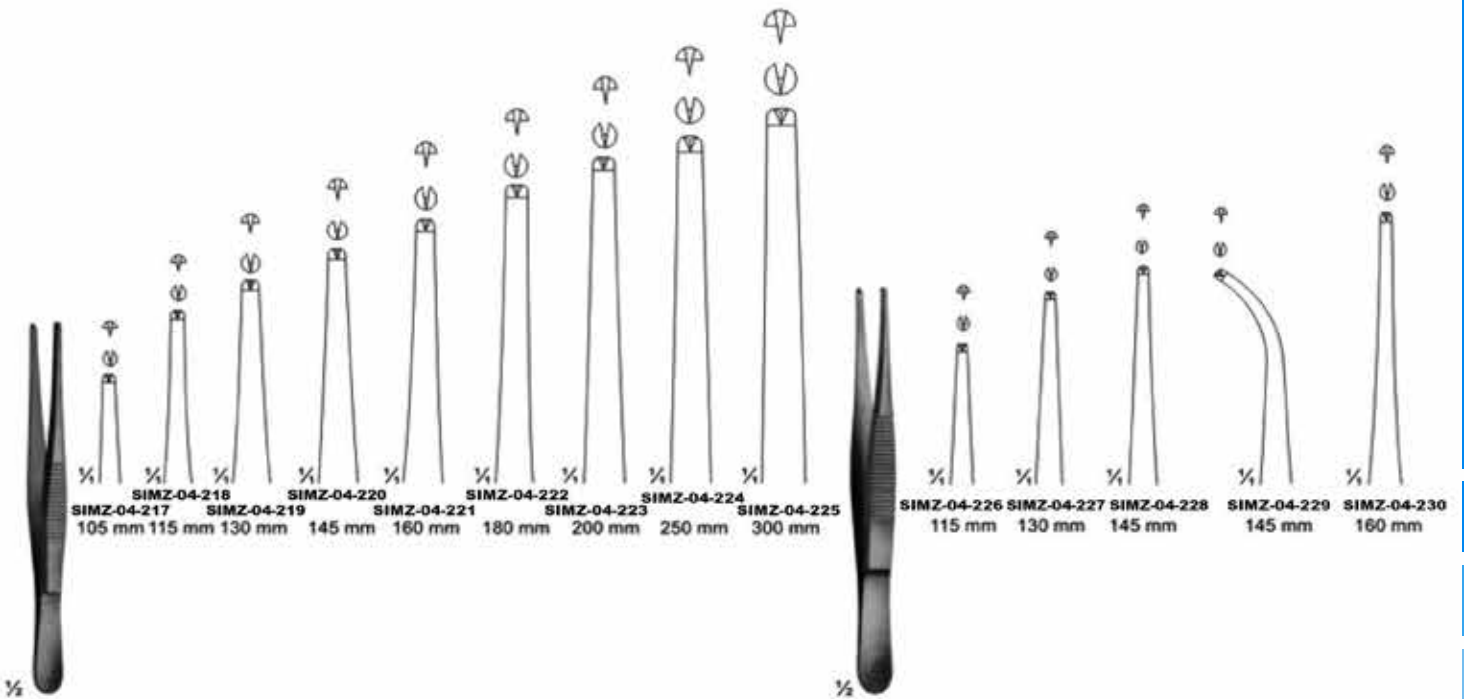

**SIMZ-04-217 - 04-225**  
**STANDARD**

**SIMZ-04-226 - 04-230**  
**GRAEFE**  
 110 mm



**SIMZ-04-231**  
LUCAE  
140 mm

**SIMZ-04-232**  
LUCAE  
1x2 teeth  
140 mm

**SIMZ-04-233**  
COTTLE  
Forceps with  
jaws toothed  
and serrated  
140 mm

**SIMZ-04-234**  
JANSEN  
160 mm

**SIMZ-04-235**  
GRUENWALD  
200 mm

**SIMZ-04-236**  
1x2 teeth  
200 mm

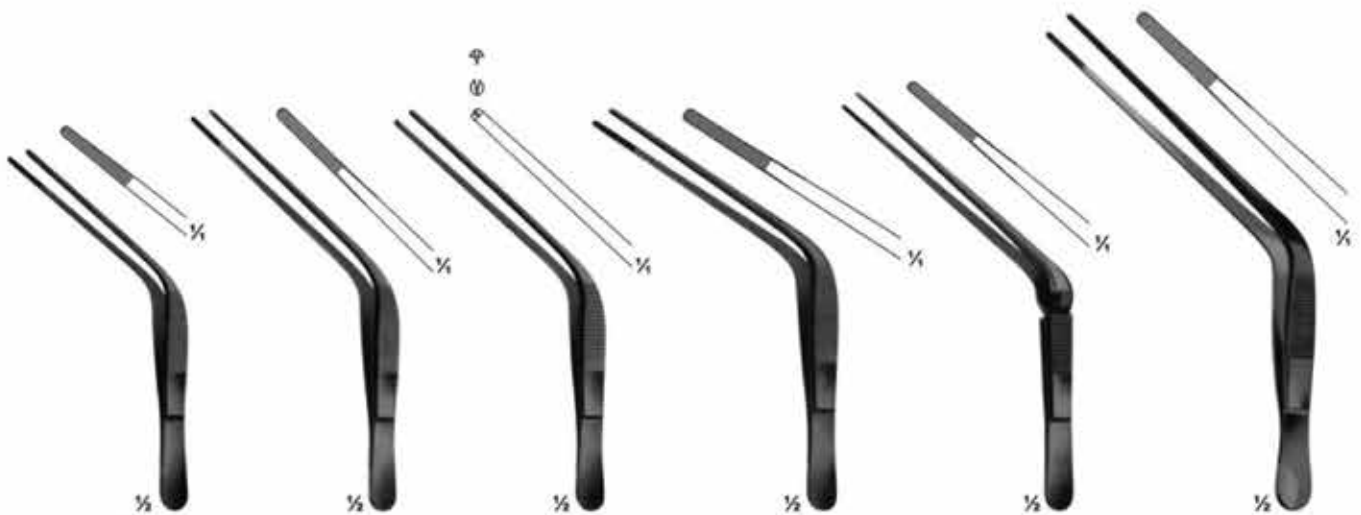

**SIMZ-04-237**  
TROELTSCH  
100 mm

**SIMZ-04-238**  
TROELTSCH  
115 mm

**SIMZ-04-239**  
TROELTSCH  
1X2 teeth  
115 mm

**SIMZ-04-240**  
WILDE  
115 mm

**SIMZ-04-241**  
TROELTSCH  
Cross action  
120 mm

**SIMZ-04-242**  
TROELTSCH  
140 mm

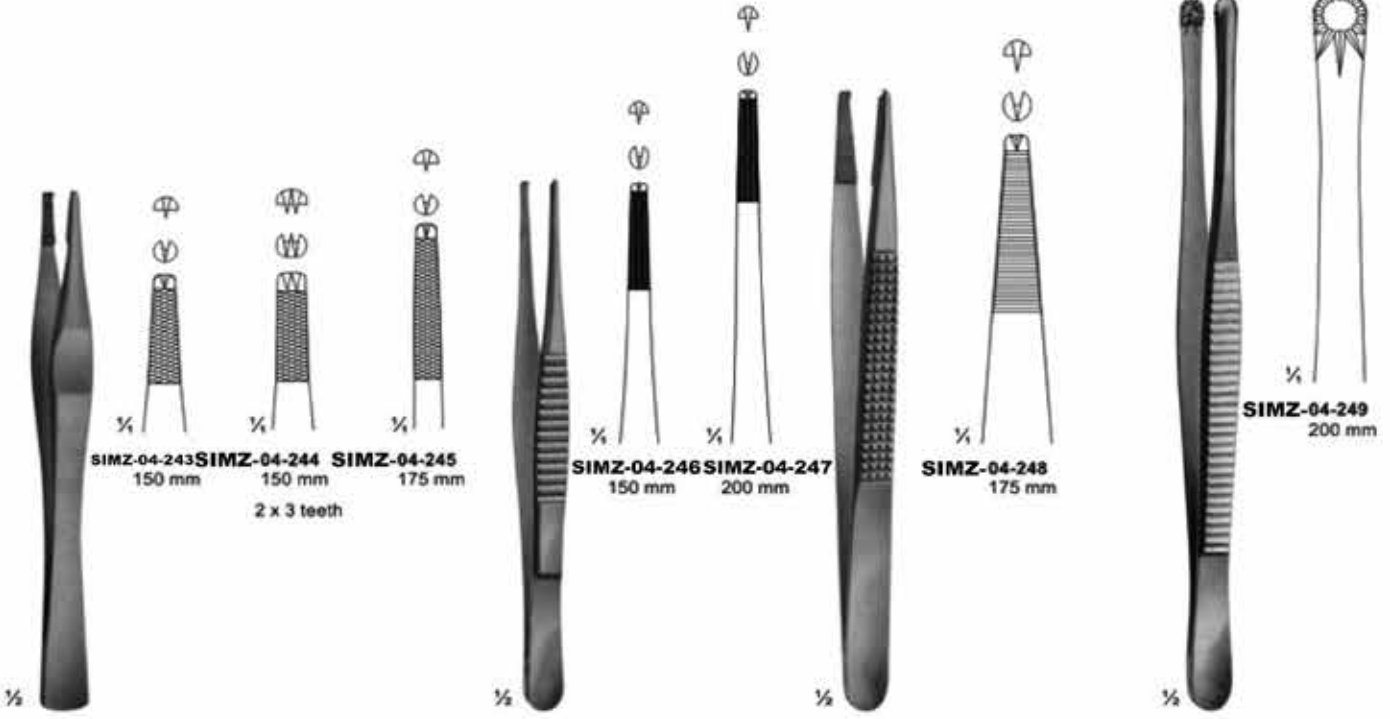

**SIMZ-04-243 - 04-245**  
LANE

**SIMZ-04-246 - 04-247**  
STRASSBURGER  
MODELL

**SIMZ-04-248**  
BONNEY

**SIMZ-04-249**  
RUSS.MODELL  
200 mm

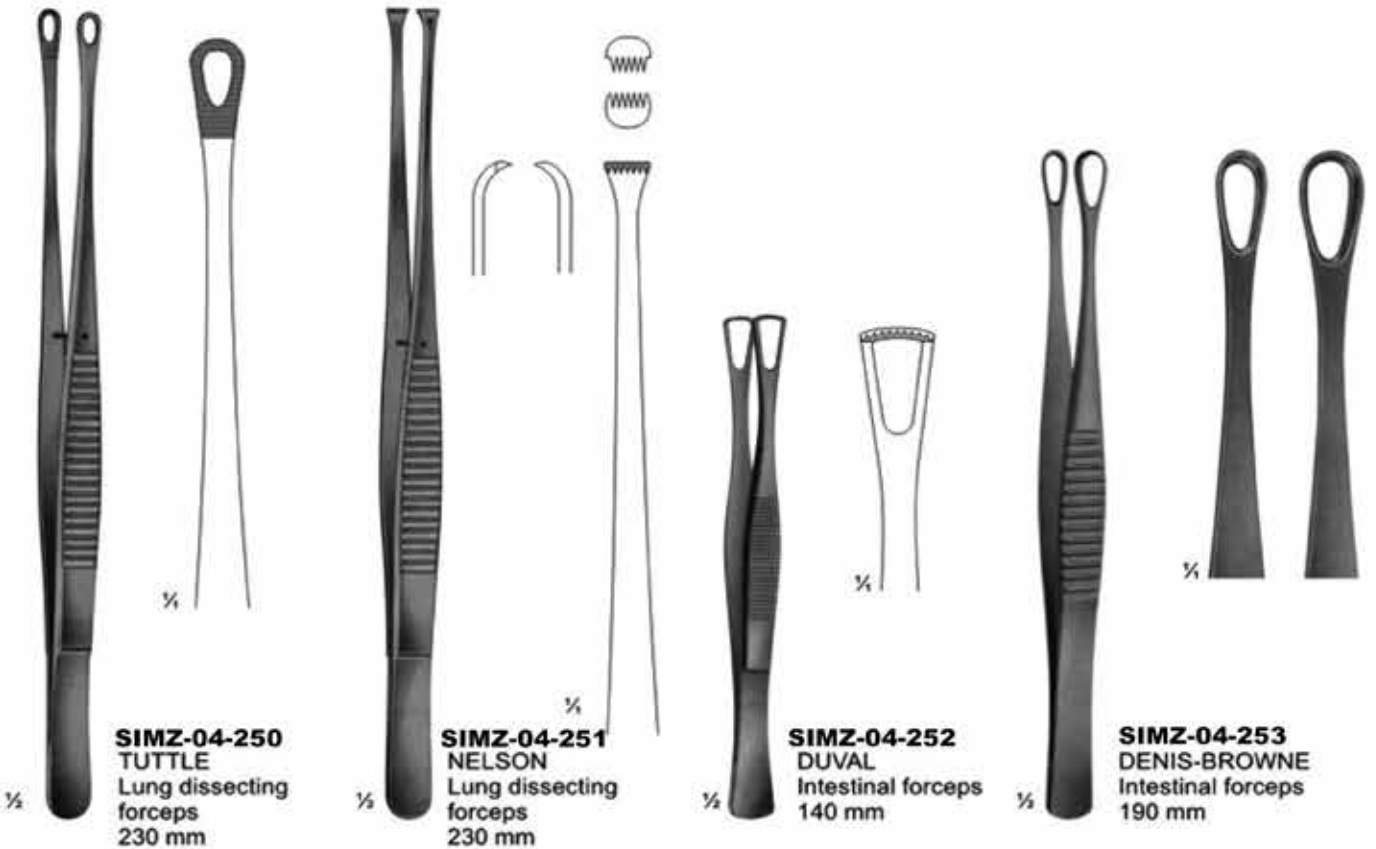

**SIMZ-04-250**  
TUTTLE  
Lung dissecting  
forceps  
230 mm

**SIMZ-04-251**  
NELSON  
Lung dissecting  
forceps  
230 mm

**SIMZ-04-252**  
DUVAL  
Intestinal forceps  
140 mm

**SIMZ-04-253**  
DENIS-BROWNE  
Intestinal forceps  
190 mm



**SIMZ-04-254** 80 mm  
**SIMZ-04-255** 75 mm  
**SIMZ-04-256** 95 mm  
**SIMZ-04-257** 115 mm  
**SIMZ-04-258** 105 mm  
**SIMZ-04-259** 140 mm  
**SIMZ-04-260** 140 mm  
**SIMZ-04-261** 120 mm

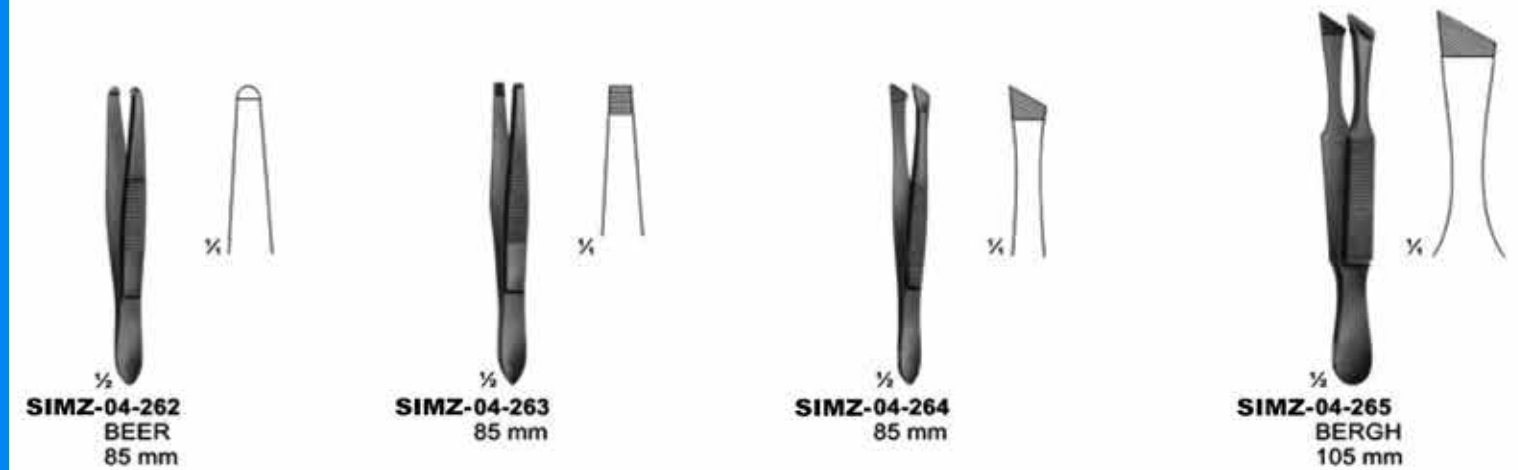

**SIMZ-04-262** 85 mm  
**SIMZ-04-263** 85 mm  
**SIMZ-04-264** 85 mm  
**SIMZ-04-265** 105 mm



**SIMZ-04-266** 85 mm  
**SIMZ-04-267** 105 mm  
**SIMZ-04-268** 95 mm  
**SIMZ-04-269** 105 mm



**SIMZ-04-270**  
BRYANT  
130 mm



**SIMZ-04-271 - 04-273**  
LISTER  
Sinus forceps

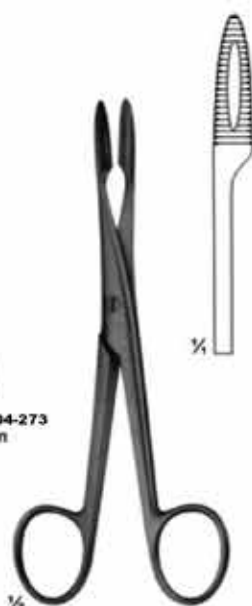

**SIMZ-04-274**  
without ratchet  
145 mm



**SIMZ-04-275**  
with ratchet  
145 mm



**SIMZ-04-276 - 04-277**  
GROSS  
without ratchet  
180 mm

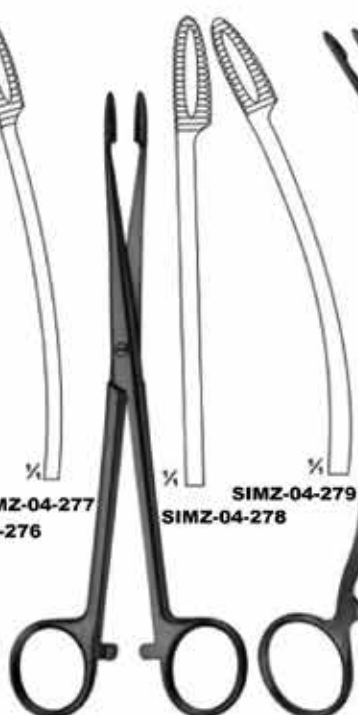

**SIMZ-04-278 - 04-279**  
GROSS  
with ratchet  
180 mm

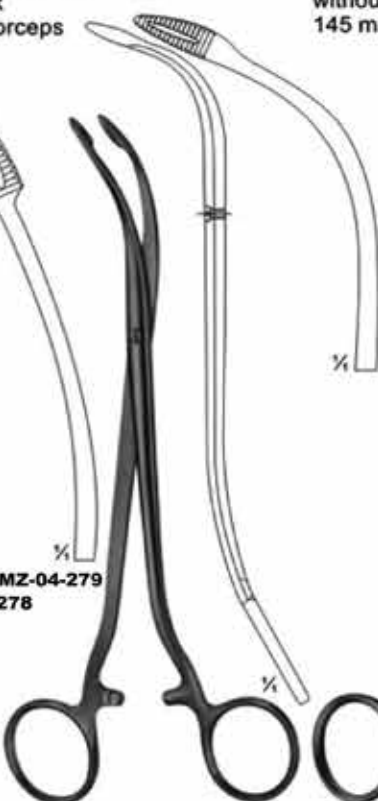

**SIMZ-04-280**  
DUPLAY  
190 mm

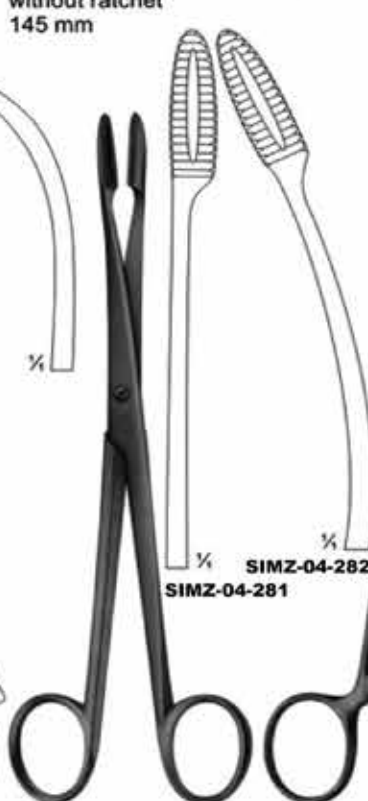

**SIMZ-04-281 - 04-282**  
GROSS  
without ratchet  
200 mm

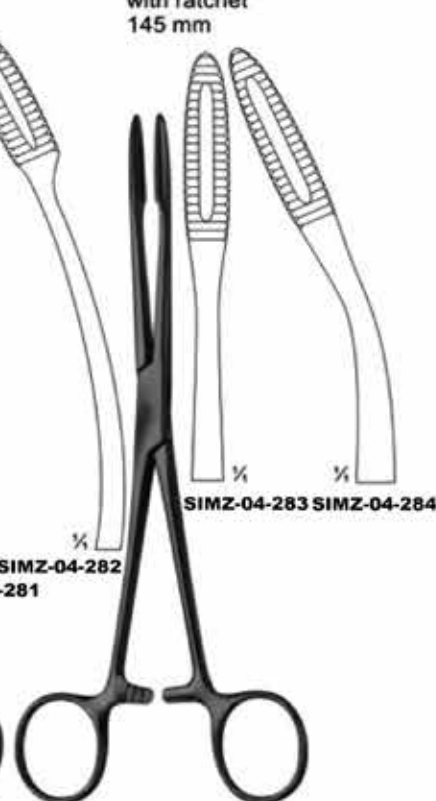

**SIMZ-04-283 - 04-284**  
GROSS  
200 mm

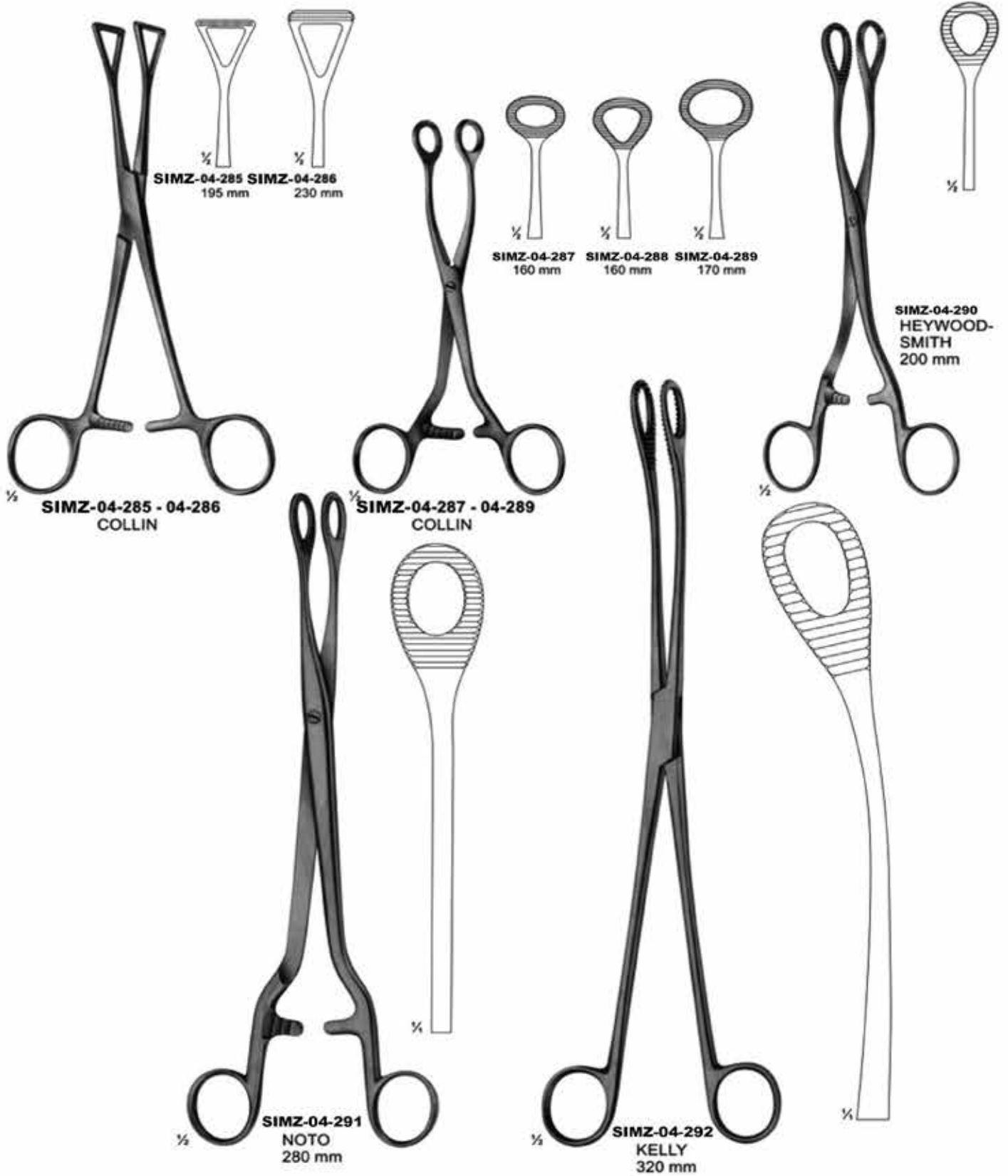



**SIMZ-04-293 - 04-294**  
FOERSTER-BALLENGER  
180 mm

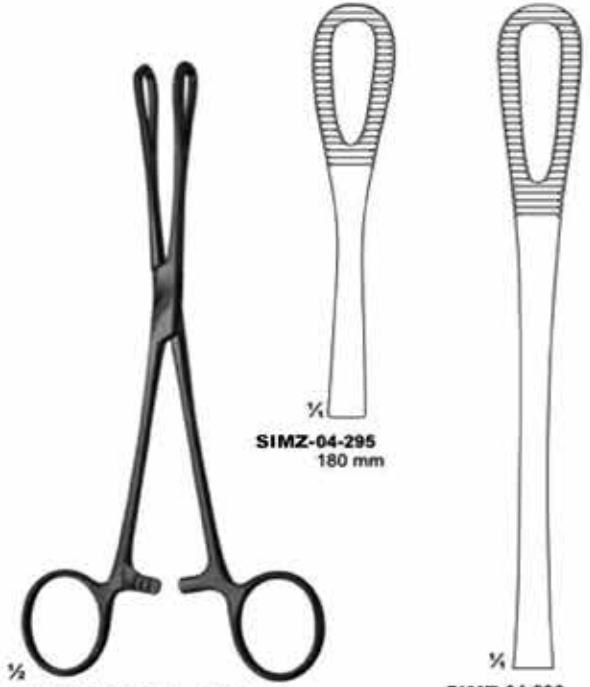

**SIMZ-04-295 - 04-296**  
RAMPLEY

**SIMZ-04-296**  
250 mm

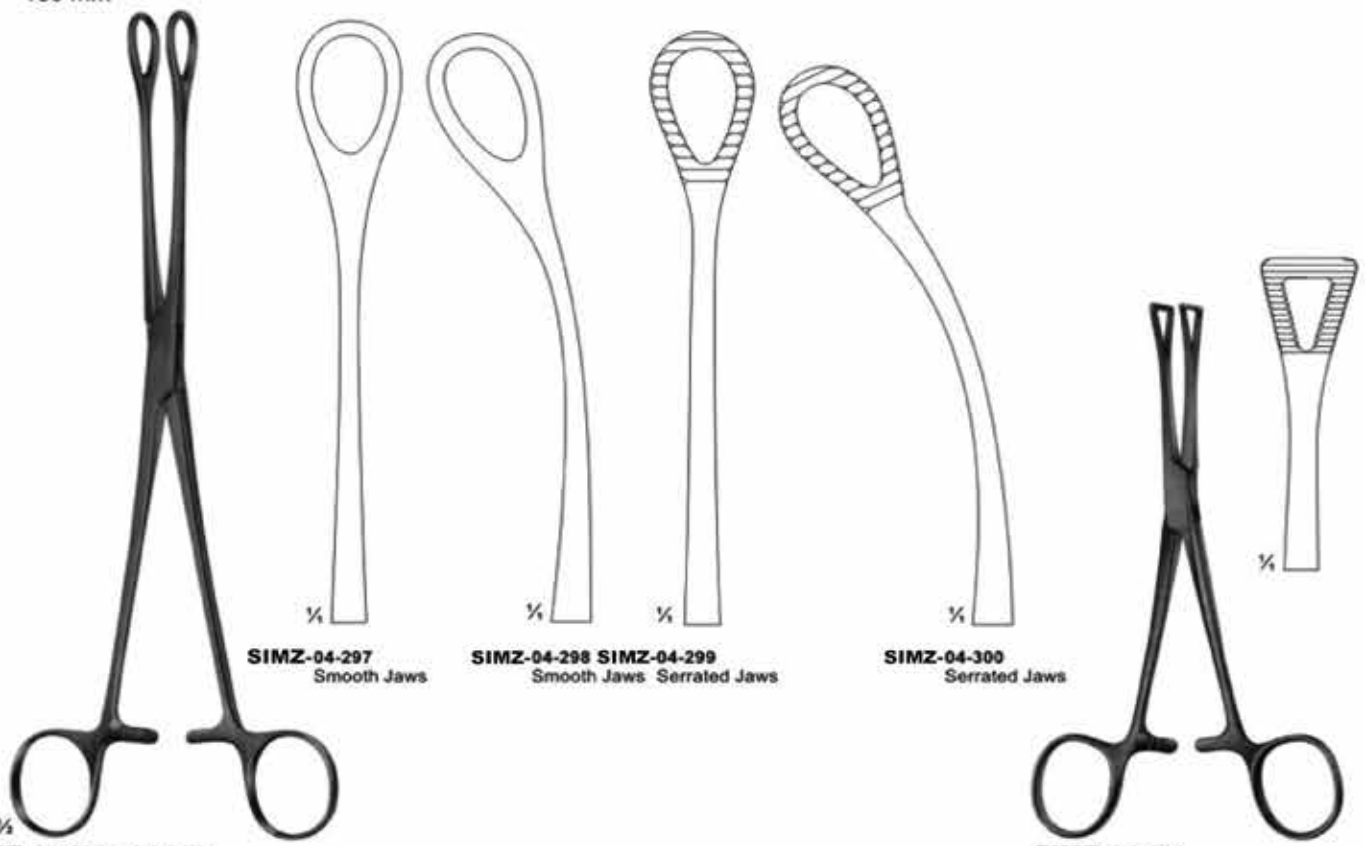

**SIMZ-04-297 - 04-300**  
FOERSTER-BALLENGER  
240 mm

**SIMZ-04-301**  
PENNINGTON  
155 mm

# Intestinal Grasping Forceps

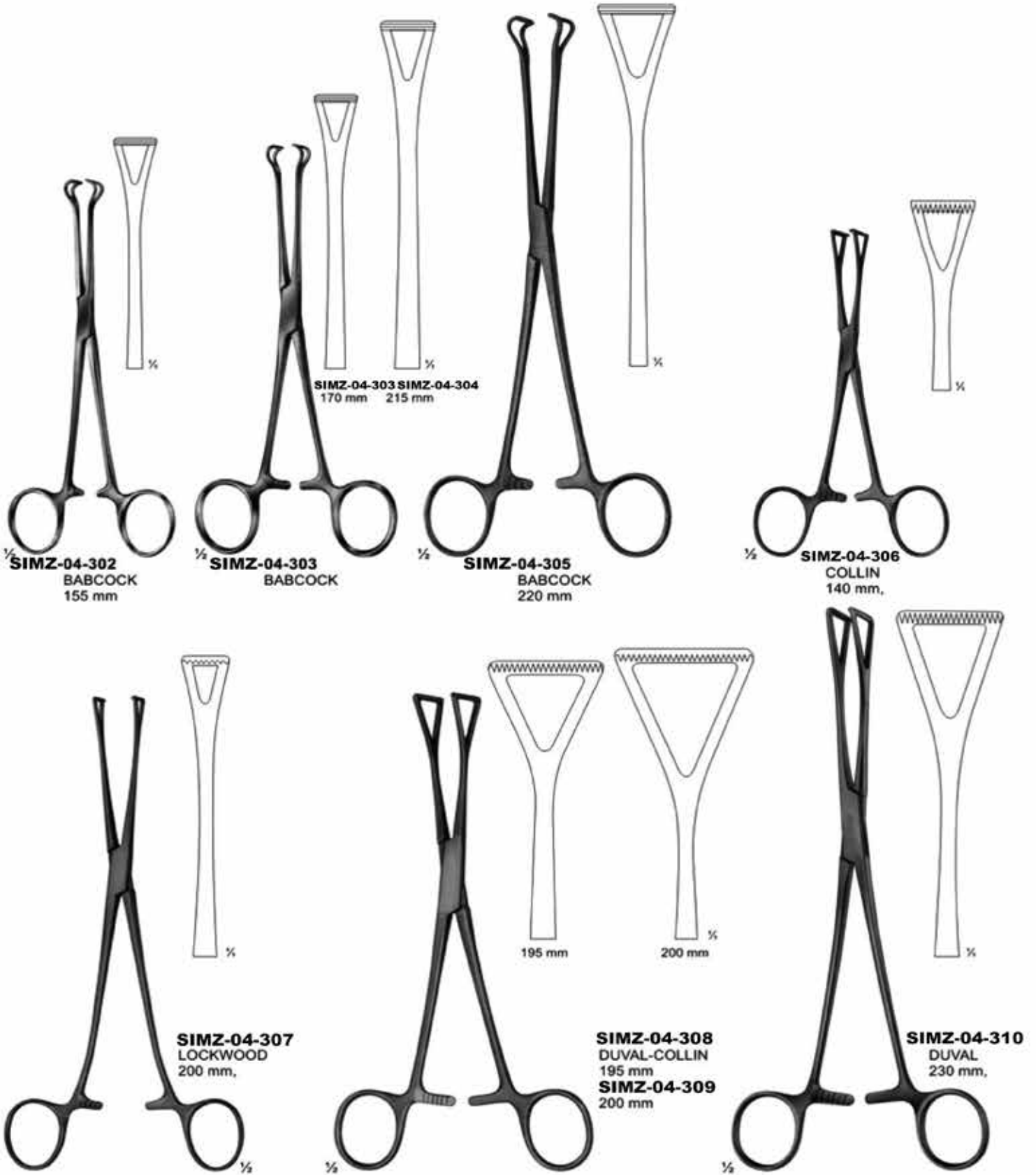

**1/2 SIMZ-04-302**  
BABCOCK  
155 mm

**1/2 SIMZ-04-303**  
BABCOCK  
170 mm

**SIMZ-04-303 SIMZ-04-304**  
170 mm 215 mm

**1/2 SIMZ-04-305**  
BABCOCK  
220 mm

**1/2 SIMZ-04-306**  
COLLIN  
140 mm,

**SIMZ-04-307**  
LOCKWOOD  
200 mm,

**SIMZ-04-308**  
DUVAL-COLLIN  
195 mm  
**SIMZ-04-309**  
200 mm

**SIMZ-04-310**  
DUVAL  
230 mm,





**SIMZ-04-311**  
**CHAPUT**  
 2 x 3 teeth  
 125 mm



**SIMZ-04-312**  
**BABY-ALLIS**  
 4 x 5 teeth  
 130 mm



**SIMZ-04-313**  
**BOYS-ALLIS**  
 5 x 6 teeth sharp  
 155 mm

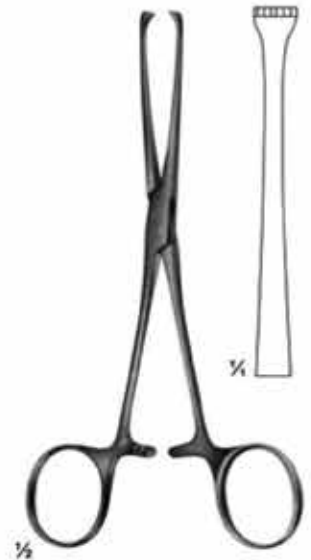

**SIMZ-04-314**  
**ALLIS**  
 5 x 6 teeth sharp  
 155 mm



**SIMZ-04-315**  
**LAHEY**  
 155 mm

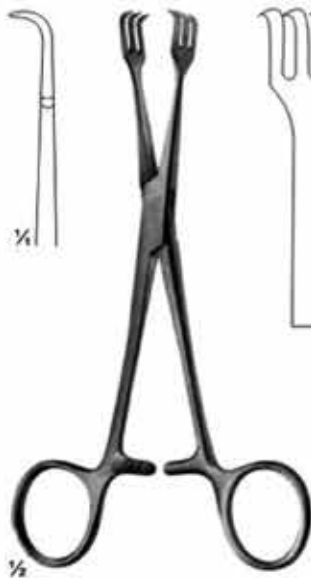

**SIMZ-04-316**  
**LAHEY**  
 155 mm

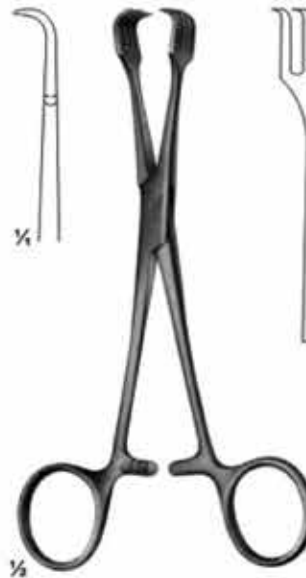

**SIMZ-04-317**  
**BRAUN**  
 155 mm

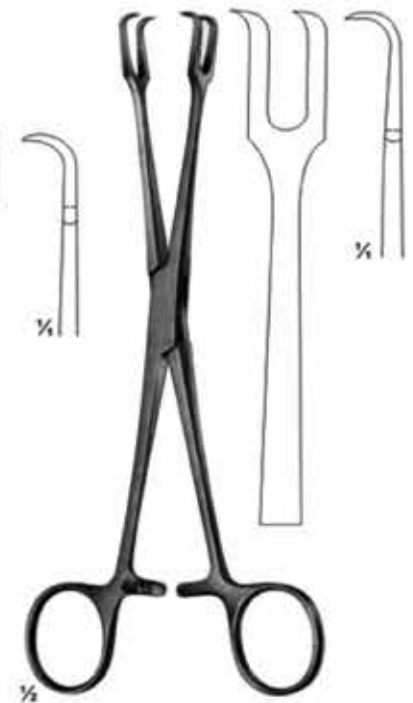

**SIMZ-04-318**  
**MUSEUX**  
 200 mm



**SIMZ-04-319**  
JONES  
85 mm

**SIMZ-04-320**  
ENGL. MOD.  
85 mm

**SIMZ-04-321 - 04-322**  
SCHAEDEL  
85 mm

**SIMZ-04-323**  
DOYEN  
110 mm

**SIMZ-04-324**  
DOYEN  
180 mm

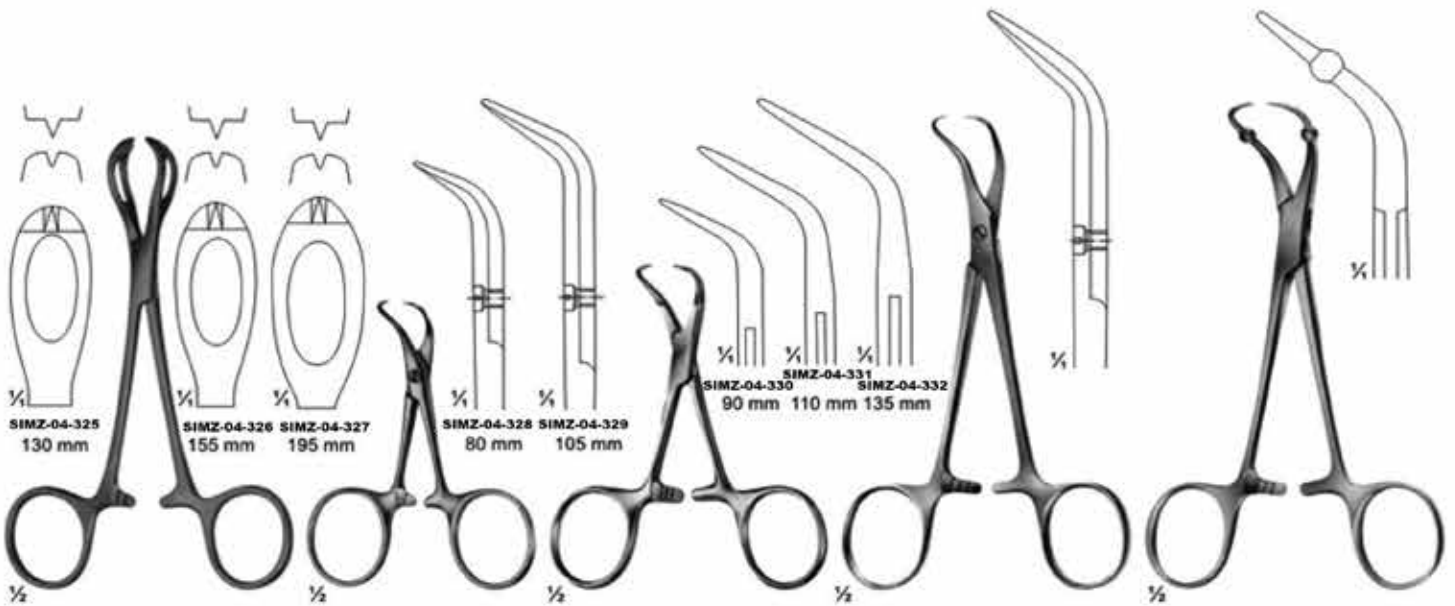

**SIMZ-04-325**  
130 mm

**SIMZ-04-326**  
155 mm

**SIMZ-04-327**  
195 mm

**SIMZ-04-328**  
80 mm

**SIMZ-04-329**  
105 mm

**SIMZ-04-330**  
90 mm

**SIMZ-04-331**  
110 mm

**SIMZ-04-332**  
135 mm

**SIMZ-04-325 - 04-327**  
LANE

**SIMZ-04-328 - 04-329**  
BACKHAUS

**SIMZ-04-330 - 04-332**  
BACKHAUS

**SIMZ-04-333**  
BACKHAUS-KOCHER  
135 mm

**SIMZ-04-334**  
ROEDER  
135 mm

## Closing force

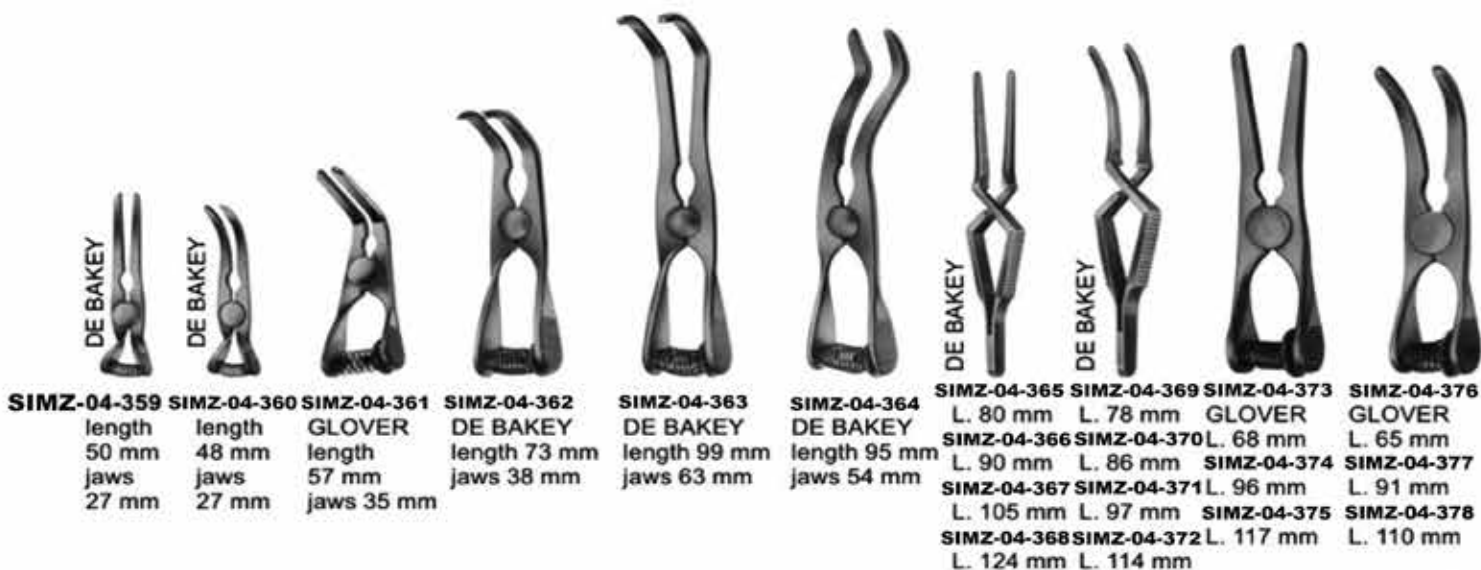



**SIMZ-04-379 - 04-382**  
HALSTED-MOSQUITO  
200 mm

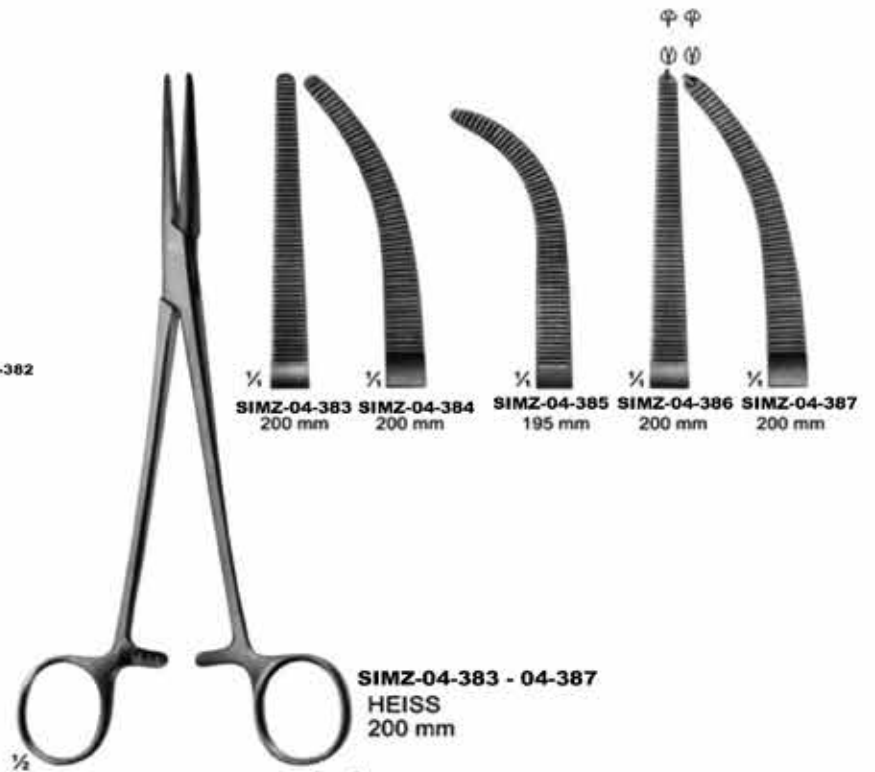

**SIMZ-04-383 - 04-387**  
HEISS  
200 mm



**SIMZ-04-388 - 04-389**  
HALSTED  
215 mm

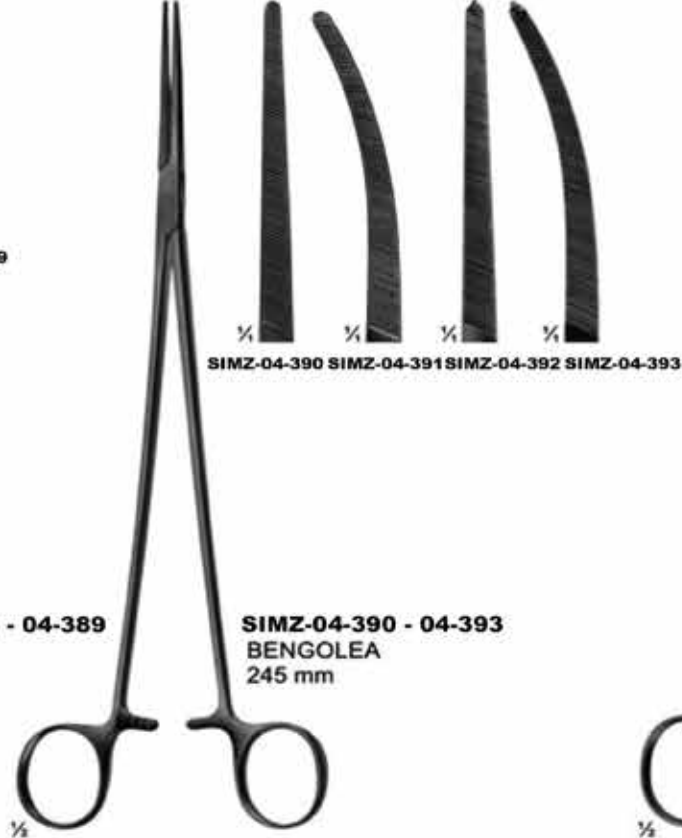

**SIMZ-04-390 - 04-393**  
BENGOLEA  
245 mm



**SIMZ-04-394**  
CRAFOORD  
245 mm



**SIMZ-04-395**  
CARREL  
85 mm



**SIMZ-04-396 - 04-399**  
BABY-MOSQUITO  
(HARTMANN)  
100 mm



**SIMZ-04-400 - 04-403**  
MICRO-HALSTED  
125 mm

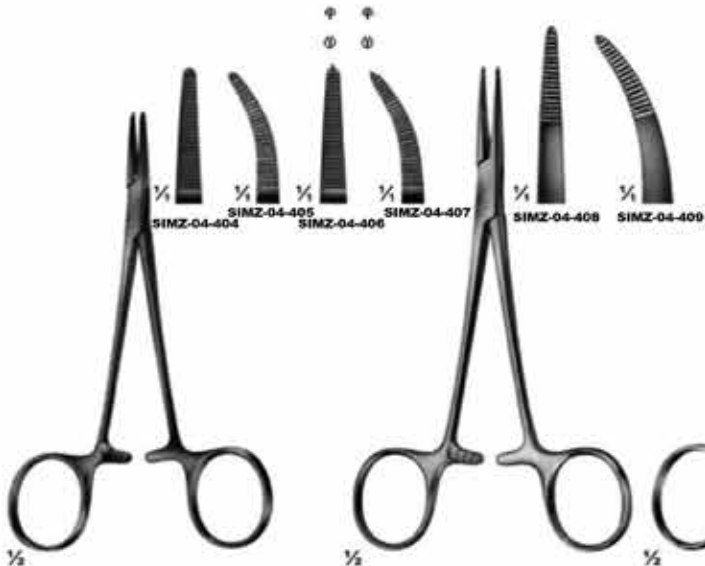

**SIMZ-04-404 - 04-407**  
HALSTED-MOSQUITO  
125 mm



**SIMZ-04-408 - 04-409**  
PROVIDENCE-HOSPITAL  
140 mm



**SIMZ-04-410 - 04-411**  
KELLY  
140 mm

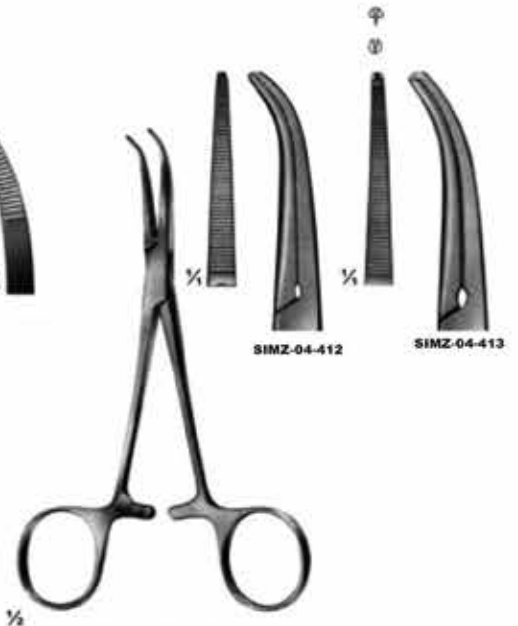

**SIMZ-04-412 - 04-413**  
DANDY  
Curved sideways  
140 mm

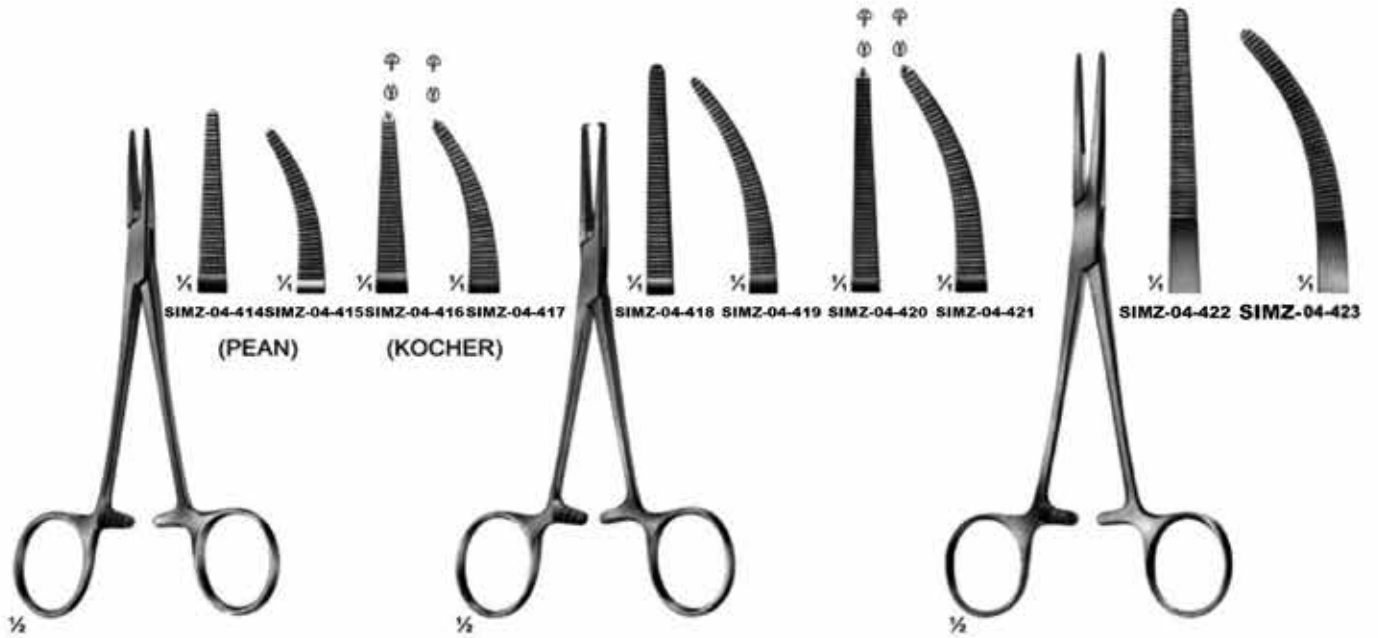

**SIMZ-04-414 - 04-417**  
**BABY-CRILE**  
 140 mm

**SIMZ-04-418 - 04-421**  
**CRILE**  
 140 mm

**SIMZ-04-422 - 04-423**  
**RANKIN**  
 160 mm

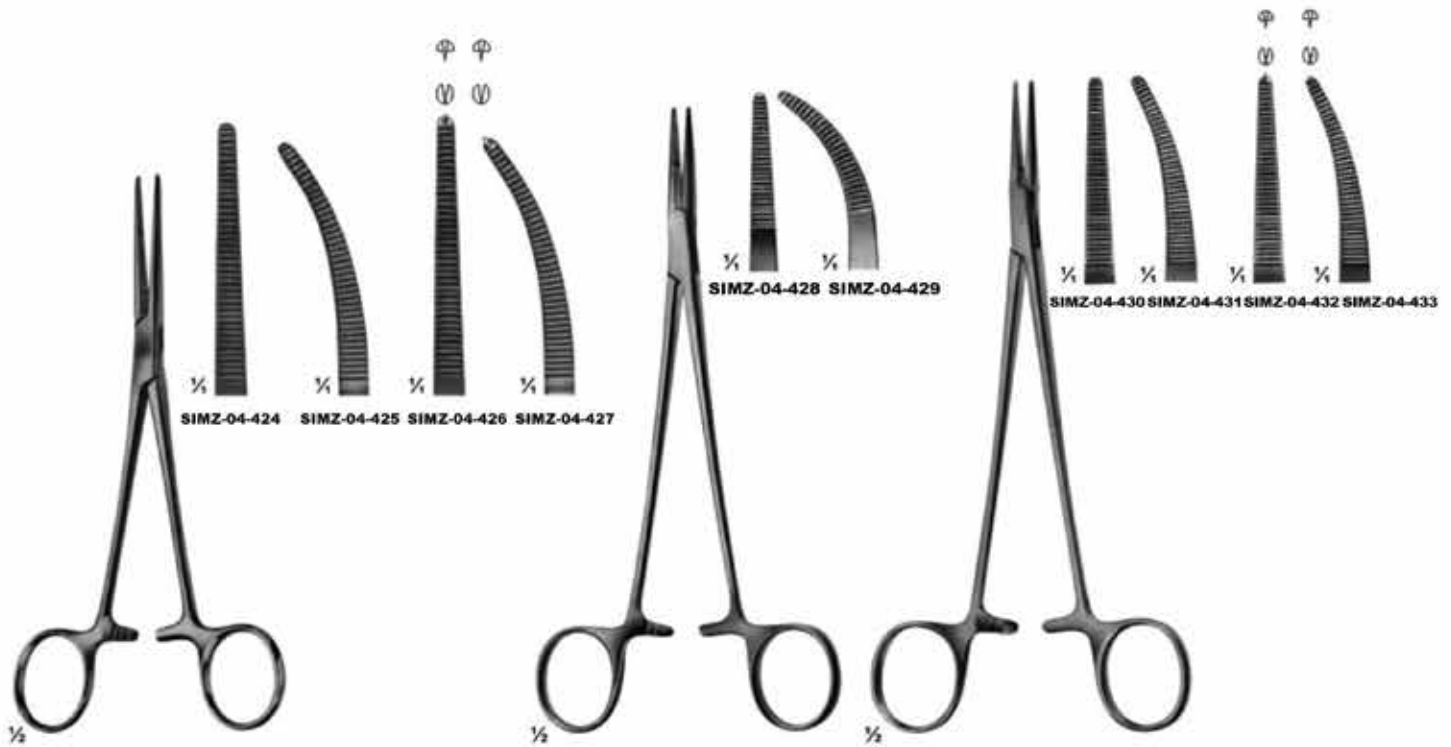

**SIMZ-04-424 - 04-427** **SIMZ-**  
**CRILE**  
 160 mm

**SIMZ-04-428 - 04-429**  
**ADSON**  
 185 mm

**SIMZ-04-430 - 04-433**  
**HALSTED**  
 185 mm



**SIMZ-04-434 - 04-437**  
PEAN  
Slender type

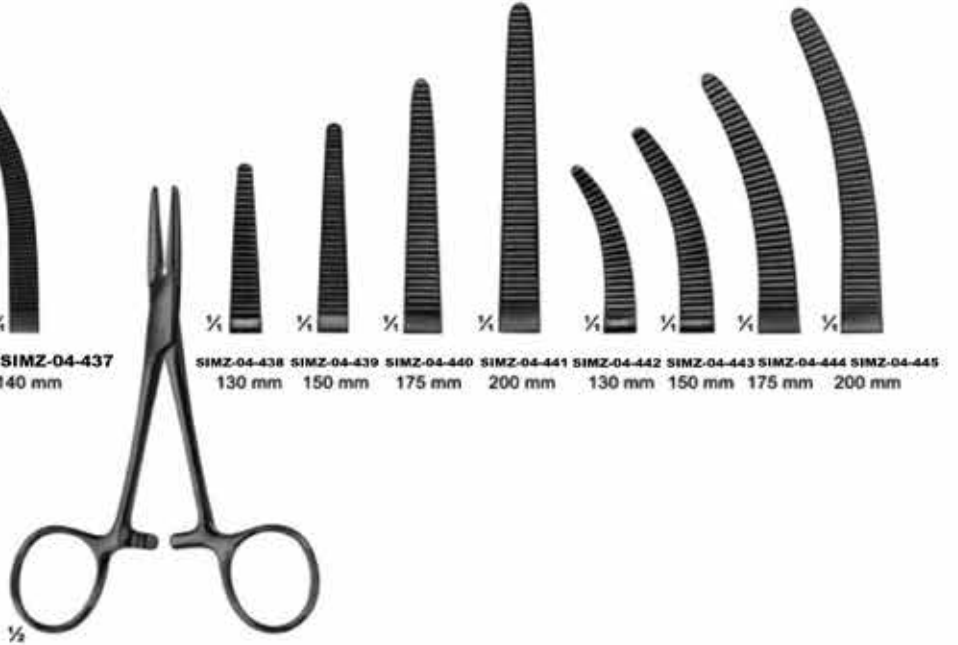

**SIMZ-04-438 - 04-445**  
SPENCER-WELLS  
Slender type

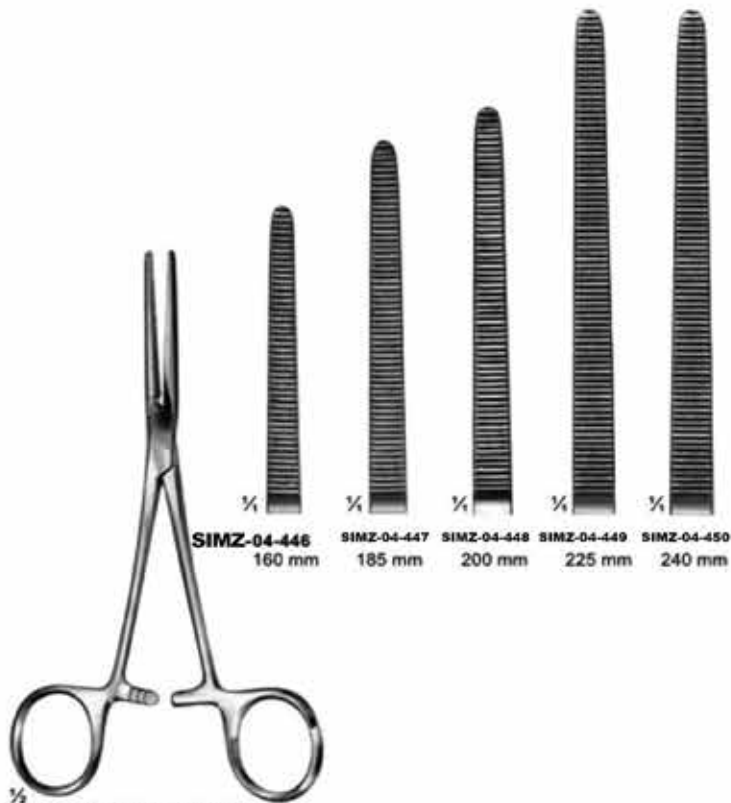

**SIMZ-04-446 - 04-455**  
ROCHESTER-PEAN

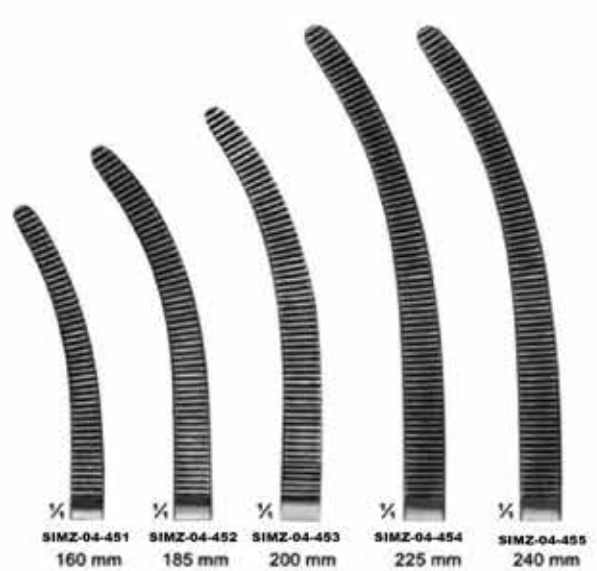

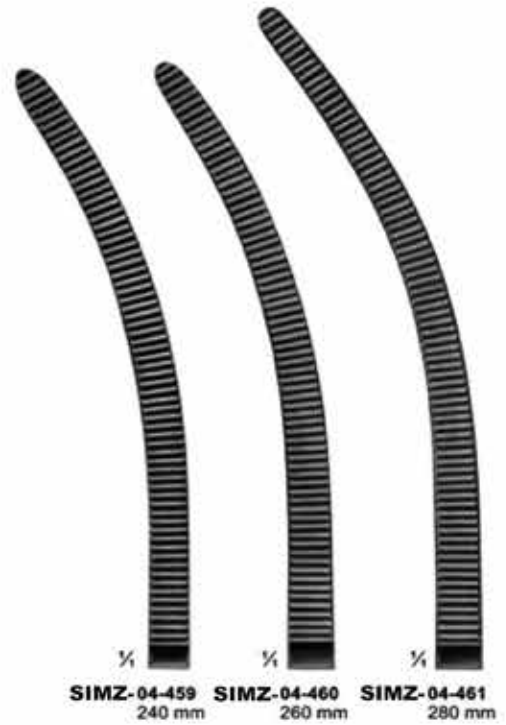
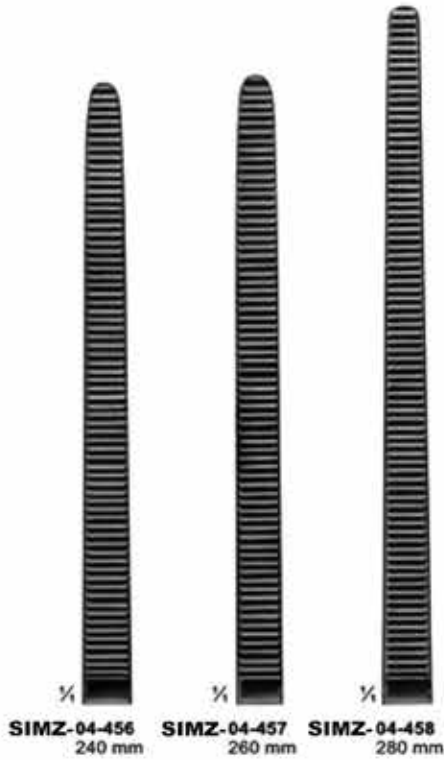



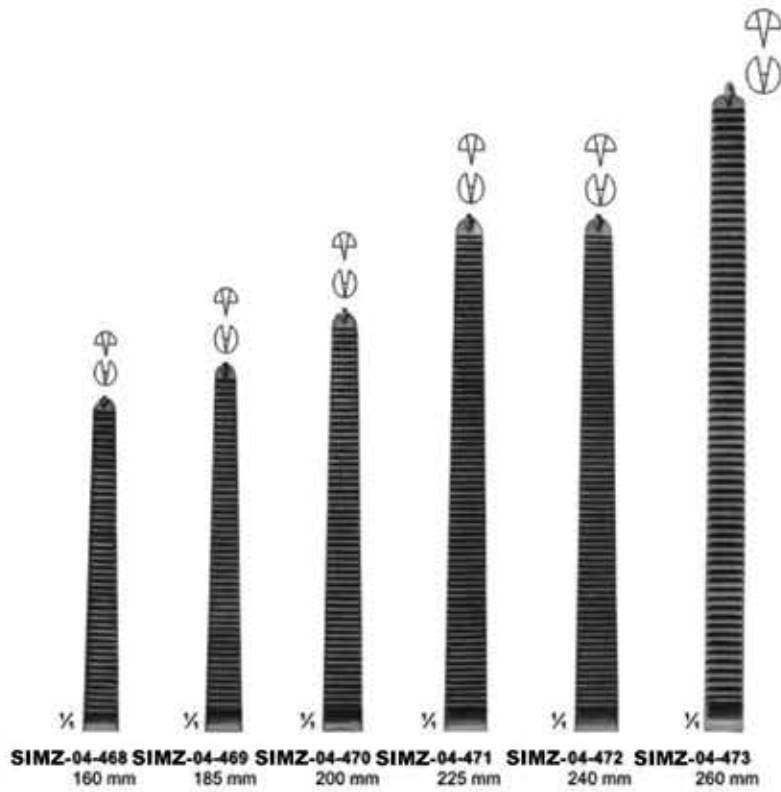

**SIMZ-04-468 - 04-479**  
KOCHER-OCHSNER

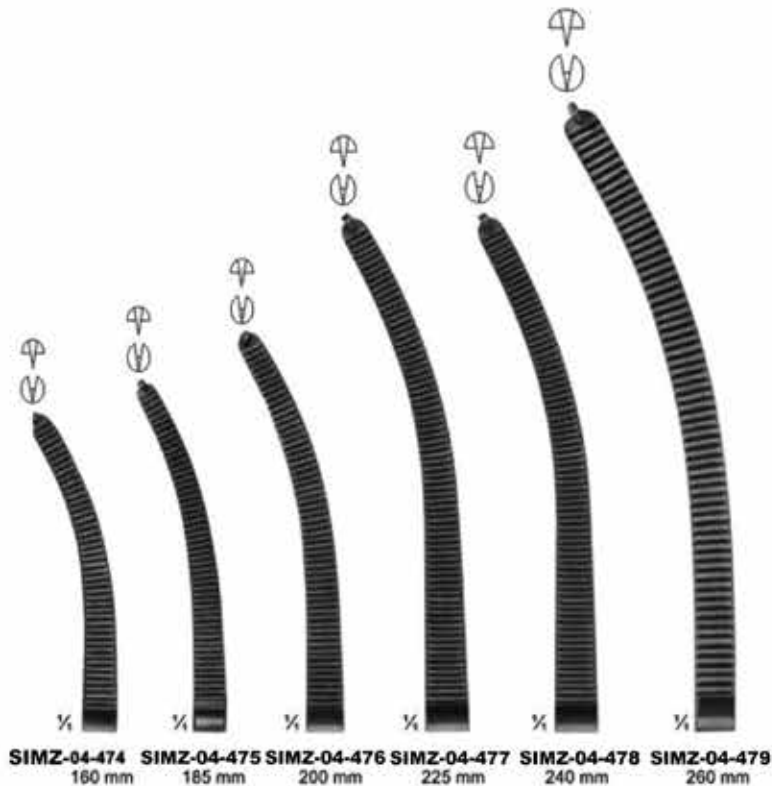

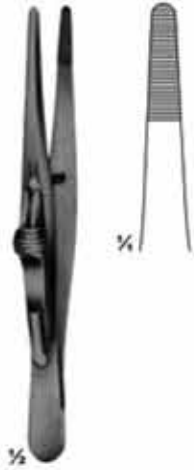

**SIMZ-04-480**  
FRICKE  
Artery forceps  
130 mm



**SIMZ-04-481**  
KRONLEIN  
130 mm



**SIMZ-04-482**  
PEAN  
125 mm



**SIMZ-04-483 - 04-484**  
PEAN

**SIMZ-04-483**  
125 mm

**SIMZ-04-484**  
140 mm



**SIMZ-04-485**  
PEAN  
125 mm



**SIMZ-04-486 - 04-487**  
PEAN

**SIMZ-04-486**  
165 mm

**SIMZ-04-487**  
185 mm



**SIMZ-04-488** 160 mm  
**SIMZ-04-489** 200 mm  
**SIMZ-04-490** 160 mm  
**SIMZ-04-491** 200 mm

**SIMZ-04-488 - 04-491**  
 ROCHESTER-CARMALT



**SIMZ-04-492** 230 mm  
**SIMZ-04-493** 240 mm

**SIMZ-04-492 - 04-493**  
 MOYNIHAN



**SIMZ-04-494** 195 mm  
**SIMZ-04-495** 220 mm  
**SIMZ-04-496** 230 mm

**SIMZ-04-494 - 04-496**  
 PEAN

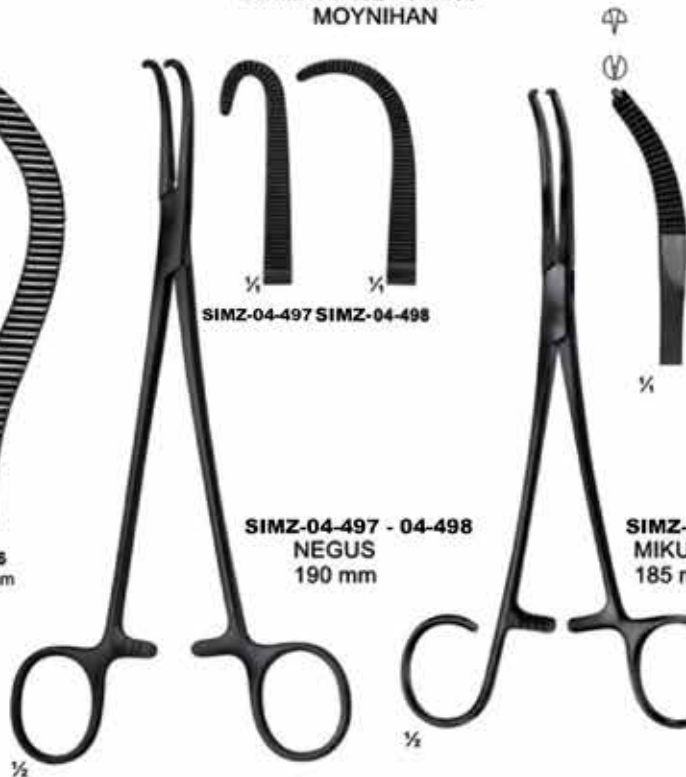

**SIMZ-04-497** **SIMZ-04-498**

**SIMZ-04-497 - 04-498**  
 NEGUS  
 190 mm

**SIMZ-04-498**  
 MIKULICZ  
 185 mm



**SIMZ-04-500**  
MIXTER-O'SHAUGNESSY  
190 mm



**SIMZ-04-501**  
HEISS  
195 mm



**SIMZ-04-502 - 04-506**  
RUMEL  
240 mm



**SIMZ-04-502 SIMZ-04-503 SIMZ-04-504 SIMZ-04-505 SIMZ-04-506**



**SIMZ-04-507**  
FINOCHIETTO  
245 mm



**SIMZ-04-508**  
MIXTER  
230 mm



**SIMZ-04-509**  
LAWRENCE  
270 mm

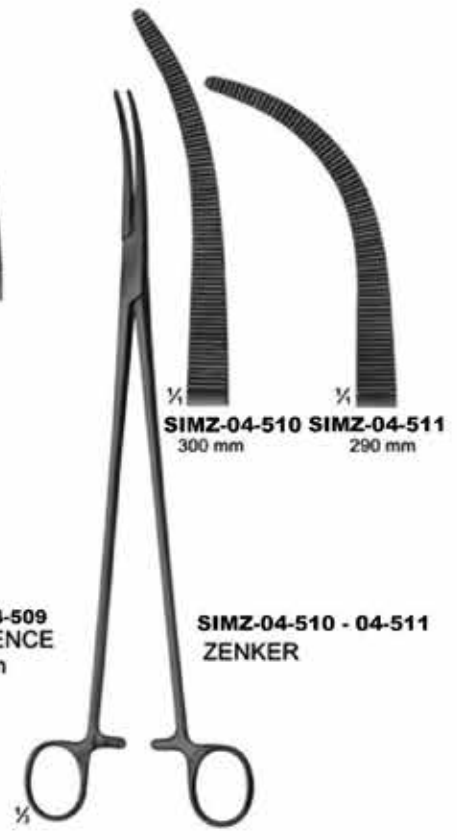

**SIMZ-04-510 SIMZ-04-511**  
300 mm 290 mm

**SIMZ-04-510 - 04-511**  
ZENKER



**SIMZ-04-512**  
**WERTHEIM**  
Hysterectomy forceps  
255 mm



¼



**SIMZ-04-513**  
**WERTHEIM**  
Parametrium clamp  
260 mm



¼



**SIMZ-04-514 - 04-516**  
**DICK**



**SIMZ-04-514** 255 mm   **SIMZ-04-515** 265 mm   **SIMZ-04-516** 275 mm

¼

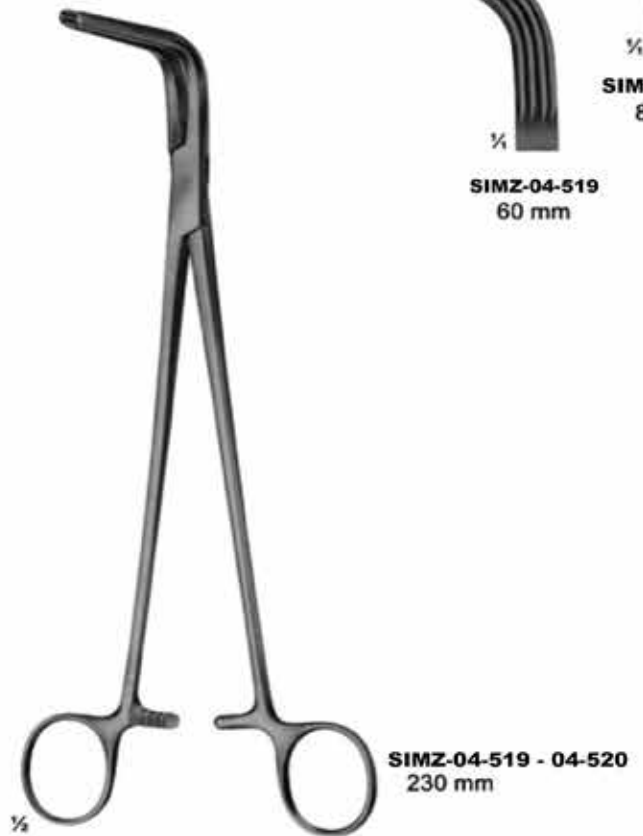
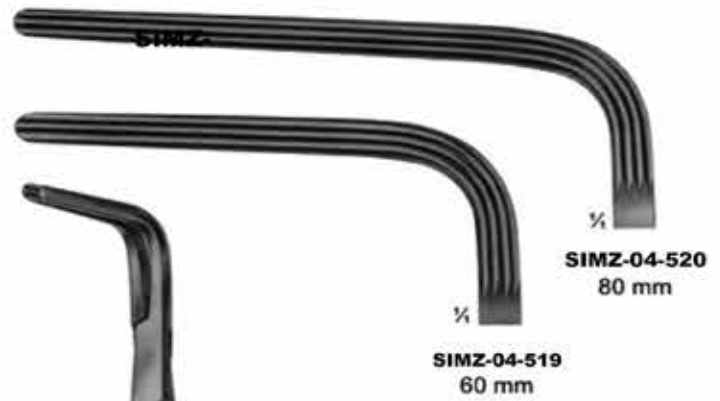



**SIMZ-05-101**  
ROHRSCHEIDER  
with copper inserts  
100 mm



**SIMZ-05-102**  
KALT  
with catch  
135 mm



**SIMZ-05-103**  
ARRUGA  
with catch  
135 mm



**SIMZ-05-104 - 105**  
CASTROVIEJO  
with catch  
145 mm



**SIMZ-05-106 - 107**  
without Catch  
160 mm



**SIMZ-05-108 - 109**  
without catch  
185 mm



**SIMZ-05-110 - 111**  
JACOBSON  
185 mm

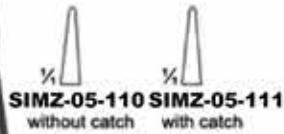

**SIMZ-05-112**  
without catch  
195 mm



**SIMZ-05-113 - 114**  
YASARGIL  
with catch  
200 mm

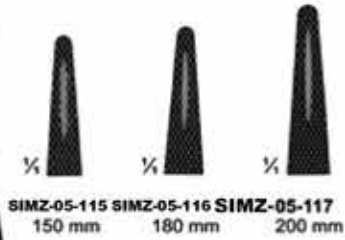

**SIMZ-05-115 - 117**  
MAYO-HEGAR  
medium fine patterns

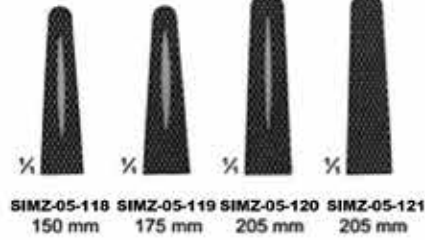

**SIMZ-05-118 - 121**  
HEGAR  
heavy patterns



**SIMZ-05-122**  
HEANEY (HEGAR)  
200 mm



**SIMZ-05-123**  
JAMESON  
230 mm



**SIMZ-05-124**  
WANGENSTEEN  
275 mm



**SIMZ-05-125**  
MASSON  
265 mm

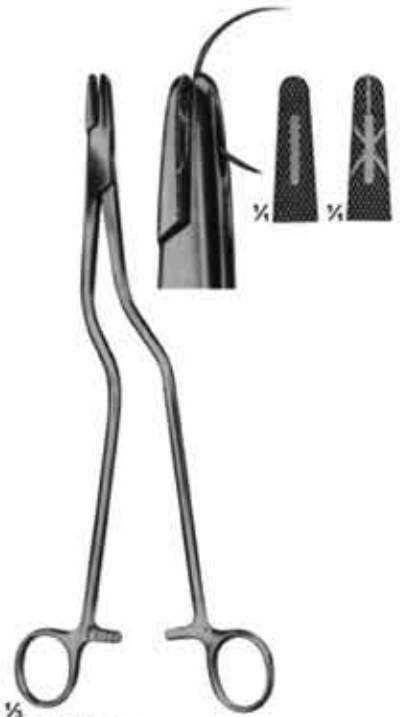

**SIMZ-05-126**  
MASSON-LUETHY  
255 mm





**SIMZ-05-127 - 128**  
HEGAR-OLSEN  
255 mm

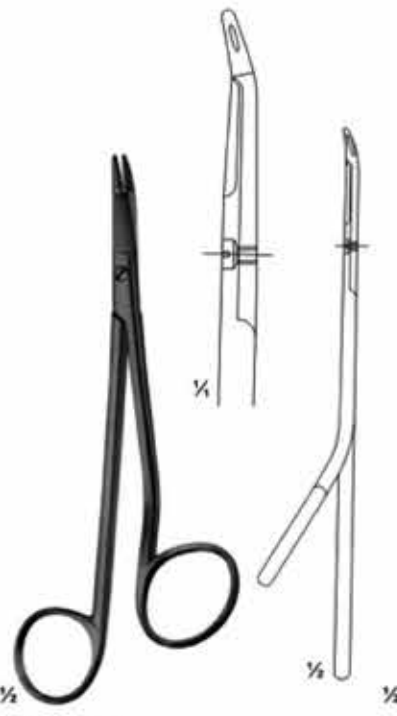

**SIMZ-05-129**  
GILLIES  
150 mm



**SIMZ-05-130**  
GILLIES  
160 mm



**SIMZ-05-131**  
EISELSBERG  
115 mm



**SIMZ-05-132**  
SCHOEMAKER-LOTH  
125 mm



**SIMZ-05-133**  
CRILE  
150 mm



**SIMZ-05-134**  
TOENNIS  
Elastic pattern for dura-or  
intestinal suture. 180 mm



**SIMZ-05-135 - 05-137**  
MATHIEU

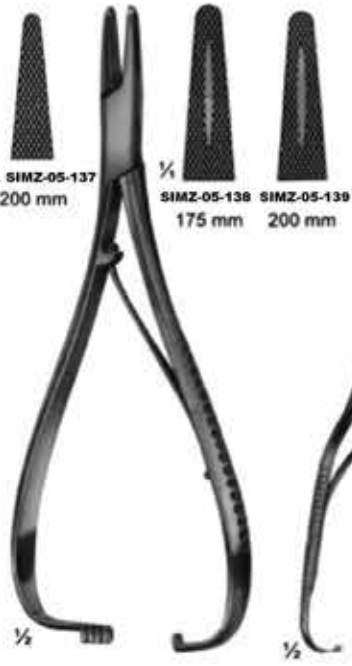

**SIMZ-05-138 - 05-139**  
MATHIEU-STILLE  
Very heavy models



**SIMZ-05-140**  
BOYNTON  
125 mm



**SIMZ-05-141**  
EISELSBERG-MATHIEU  
For palate suture  
195 mm



**SIMZ-05-142 - 05-143**



**SIMZ-05-144**



**SIMZ-05-145**



**SIMZ-05-146**

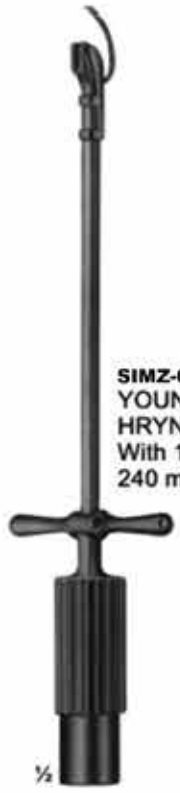

**SIMZ-05-147**  
YOUNG-HRYNTSCHAK  
With 1 needle  
240 mm



**SIMZ-05-148**  
YOUNG-MILLIN  
With 1 needle  
200 mm



**SIMZ-05-149**  
MILLIN  
Ligature holding  
forceps. 245 mm

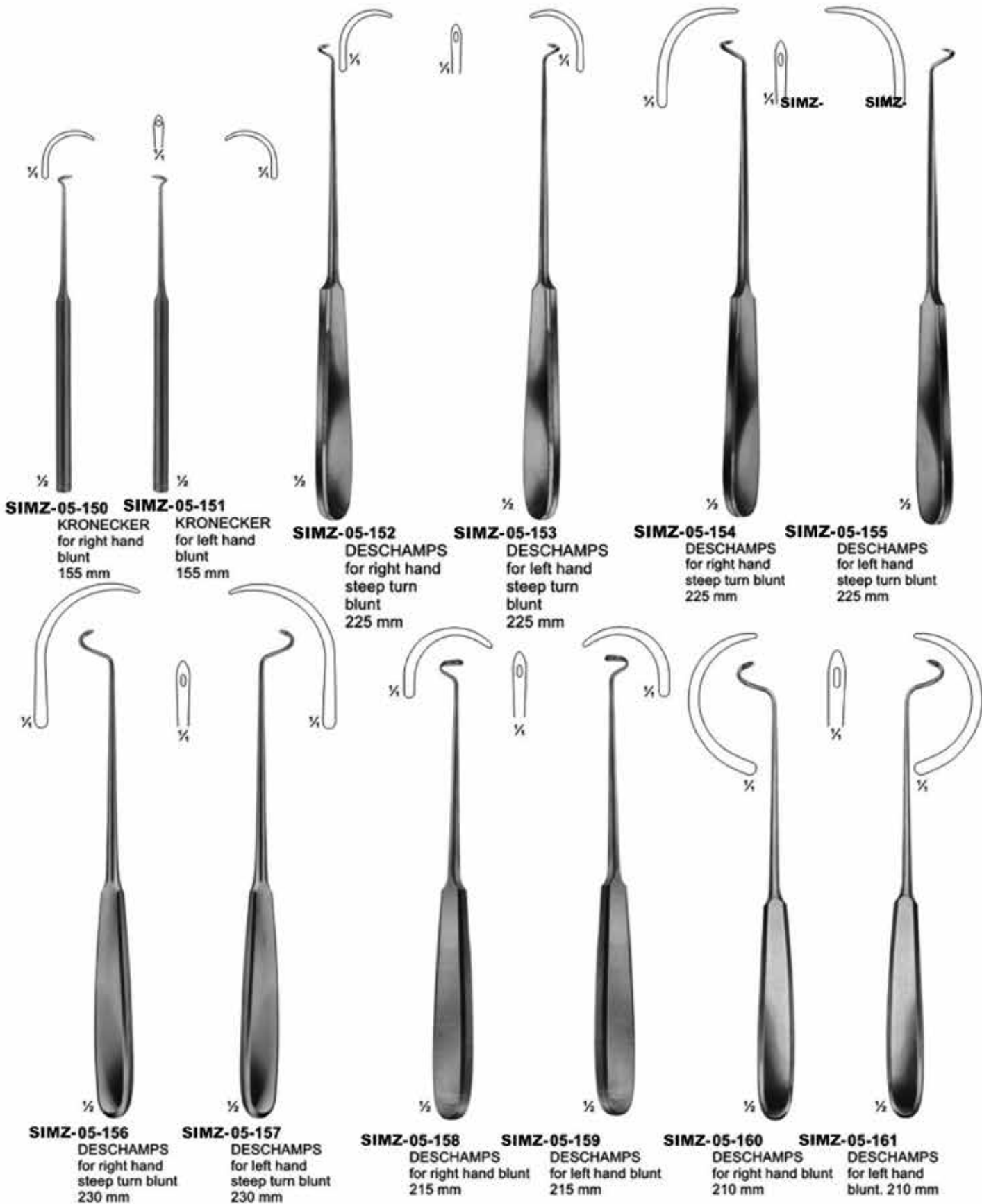

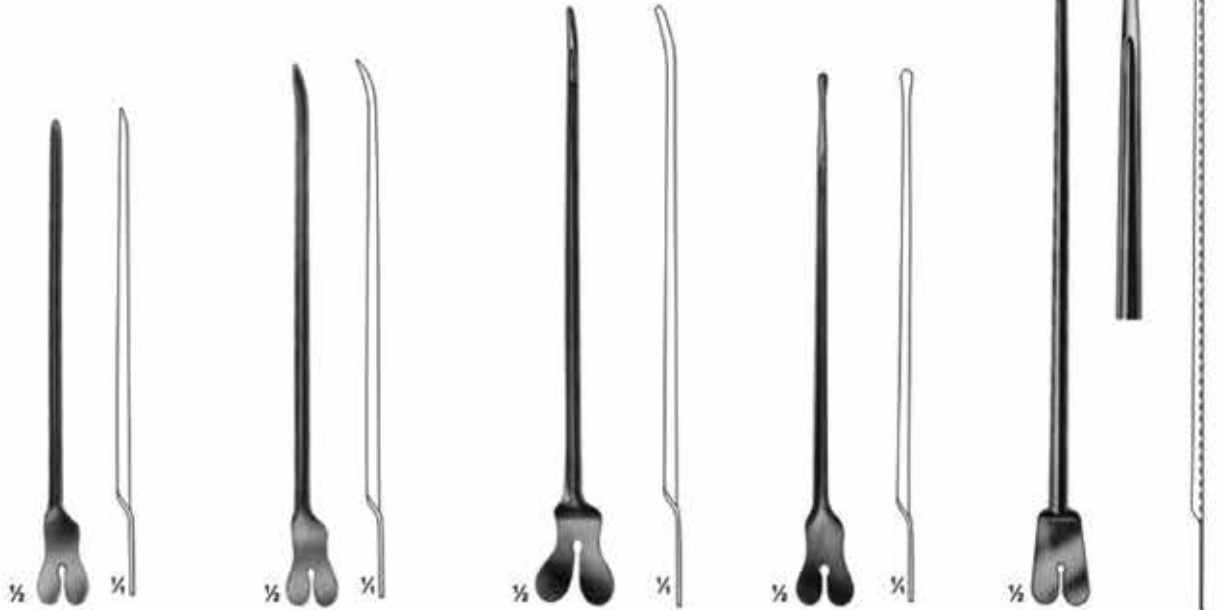

**SIMZ-05-162** 130 mm  
**SIMZ-05-163** 145 mm  
**SIMZ-05-164** 160 mm  
 Directors

**SIMZ-05-165**  
**DOYEN**  
 145 mm  
 Directors

**SIMZ-05-166**  
**NELATON**  
 160 mm  
 Directors

**SIMZ-05-167**  
 Director with tip  
 Diam. Of tip 3,3 mm  
 140 mm

**SIMZ-05-168**  
**BRODIE**  
 Director with tip,  
 Diam. Of tip 3,5 mm  
 200 mm

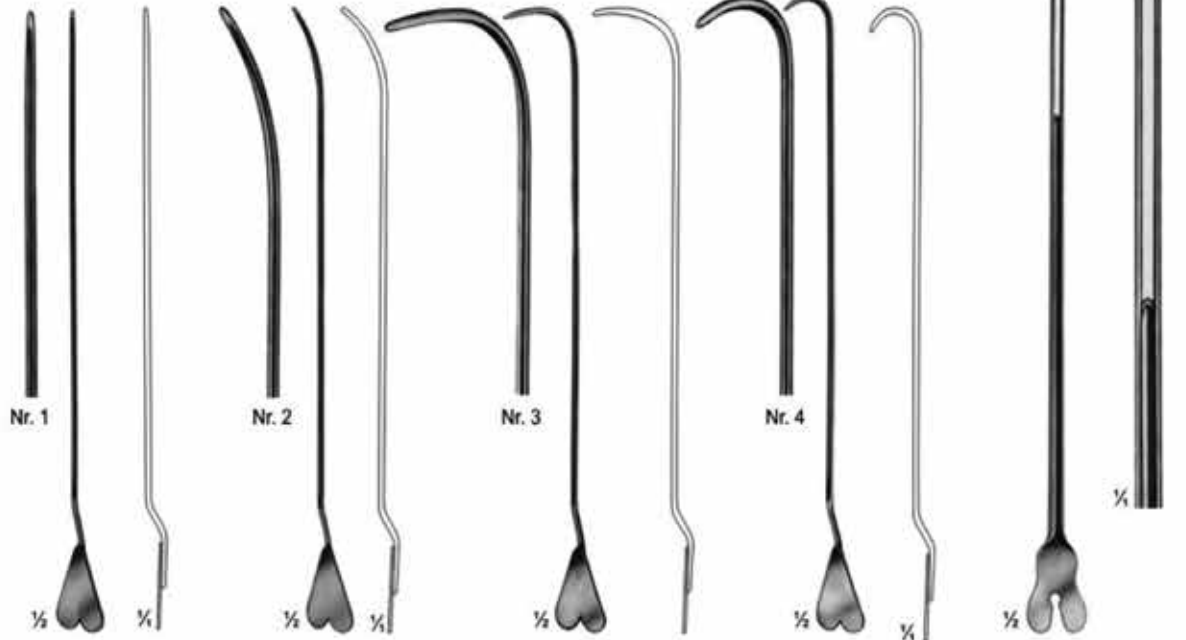

**SIMZ-05-169**  
**LOCKHART-MUMMERY**  
 165 mm

**SIMZ-05-170**  
**LOCKHART-MUMMERY**  
 165 mm

**SIMZ-05-171**  
**LOCKHART-MUMMERY**  
 165 mm

**SIMZ-05-172**  
**LOCKHART-MUMMERY**  
 165 mm

**SIMZ-05-173**  
 Director with wire  
 loop, malleable  
 190 mm



**SIMZ-05-174** 2,5 mm  
**SIMZ-05-175** 2,5 mm  
**SIMZ-05-176** 3,0 mm



**SIMZ-05-177** Myrtle leaf probe  
 145 mm



**SIMZ-05-178** 130 mm  
**SIMZ-05-179** 145 mm  
**SIMZ-05-180** 160 mm  
**SIMZ-05-181** 180 mm  
**SIMZ-05-182** 200 mm



**SIMZ-05-183** Probes

**SIMZ-05-174** 145 mm  
**SIMZ-05-175** 160 mm  
**SIMZ-05-176** 200 mm  
 Probes with eye



**SIMZ-05-184** 1/8  
 Double ended probe,  
 malleable, diam. of tips  
 3 mm with hole  
 190 mm



**SIMZ-05-185**  
 Double ended probes,  
 tin, malleable,  
 diam. of tips  
 3,5 mm with hole  
 250 mm. 300 mm



**SIMZ-05-186** 1/4  
 Double ended probes,  
 tin, malleable,  
 diam. of tips 4 mm  
 400 mm



**SIMZ-05-187** 1,5 mm  
**SIMZ-05-188** 2,0 mm  
**SIMZ-05-189** 2,5 mm  
 300 mm



## SIMZ-05-190

Suturing instruments set, in metal case consisting of: Scissors, curved, sharp/sharp, 115mm  
25 MICHEL clip, 16 x 3mm  
1 Delicate tissue forceps, 130mm  
1 Scalpel, bellied  
1 MATHIEU needle holder, 140mm  
1 Perforated metal case, stainless containing:  
1 Suture needle  
1 item 1 item



## SIMZ-05-191

Pocket instrument set, in metal case consisting of:

### Bottom tray

1 MATHIEU needle holder, 140mm  
1 MICHEL clip forceps, combined  
1 Myrtle leaf probe, 130mm  
1 Sharp double curette  
1 Skin hook  
1 Detachable scalpel handle, no.4  
1 Perforated metal case, containing  
6 Scalpel blades  
1 Perforated metal case, stainless, containing  
1 Suture needle  
1 item  
1 item

### Top tray

1 Tissue forceps, 130mm  
1 KOCHER haemostatic forceps, 130mm  
1 Straight surgical scissors, 130mm  
1 Dissecting forceps, 130mm  
1 FEILCHENFELD splinter forceps, 115mm  
25 MICHEL clip, 16 x 3mm  
1 Flacon of suture skin, sterile in alcohol



## SIMZ-05-192

Pocket instrument set, in metal case consisting of:

### Bottom tray

1 MAYO-HEGER needle holder, 150mm  
1 MICHEL clip forceps, combined  
1 Myrtle leaf probe, 130mm  
1 Sharp double curette  
1 Skin hook  
1 Detachable scalpel handle, no. 4  
1 Perforated metal case, consisting  
6 Scalpel blades  
1 Perforated metal case, stainless, consisting:  
1 Suture needle  
1 item, & 1 item

### Top tray

1 Tissue forceps, 130mm  
1 CRILE haemostatic forceps, 140mm  
1 Straight surgical scissors, 130mm  
1 Dissecting forceps, 130mm  
1 FEILCHENFELD splinter forceps, 115mm  
25 MICHEL clip, 16 x 3mm  
1 Flacon of suture silk, sterile in alcohol



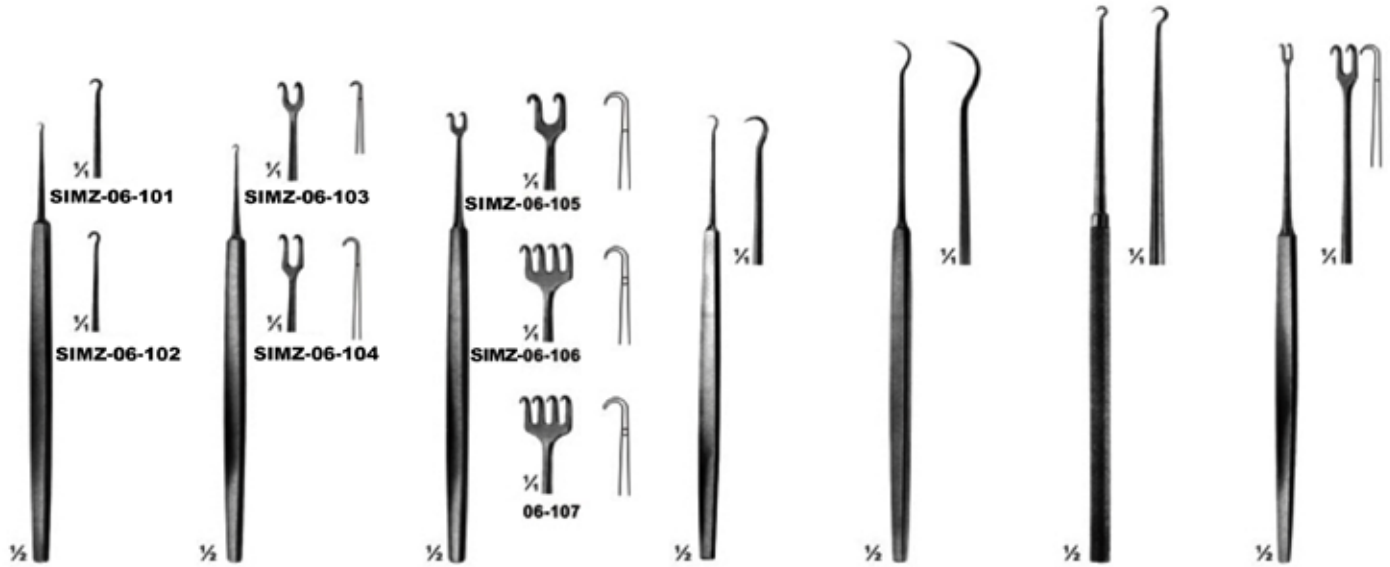

<b>SIMZ-06-101</b> Sharp <b>SIMZ-06-102</b> Blunt GRAEFE 125 mm	<b>SIMZ-06-103</b> 125 mm <b>SIMZ-06-104</b> 130 mm sharp GUTHRIE	<b>SIMZ-06-105</b> 130 mm <b>SIMZ-06-106</b> 135 mm sharp ROLLET <b>06-107</b> 135 mm blunt	<b>SIMZ-06-108</b> FRAZIER Dura retractors 130 mm	<b>SIMZ-06-109</b> TONNIS Dura retractors 150 mm	<b>SIMZ-06-110</b> KILNER 160 mm	<b>SIMZ-06-111</b> FREER 150 mm
--	--	--	--	---	--	---------------------------------------

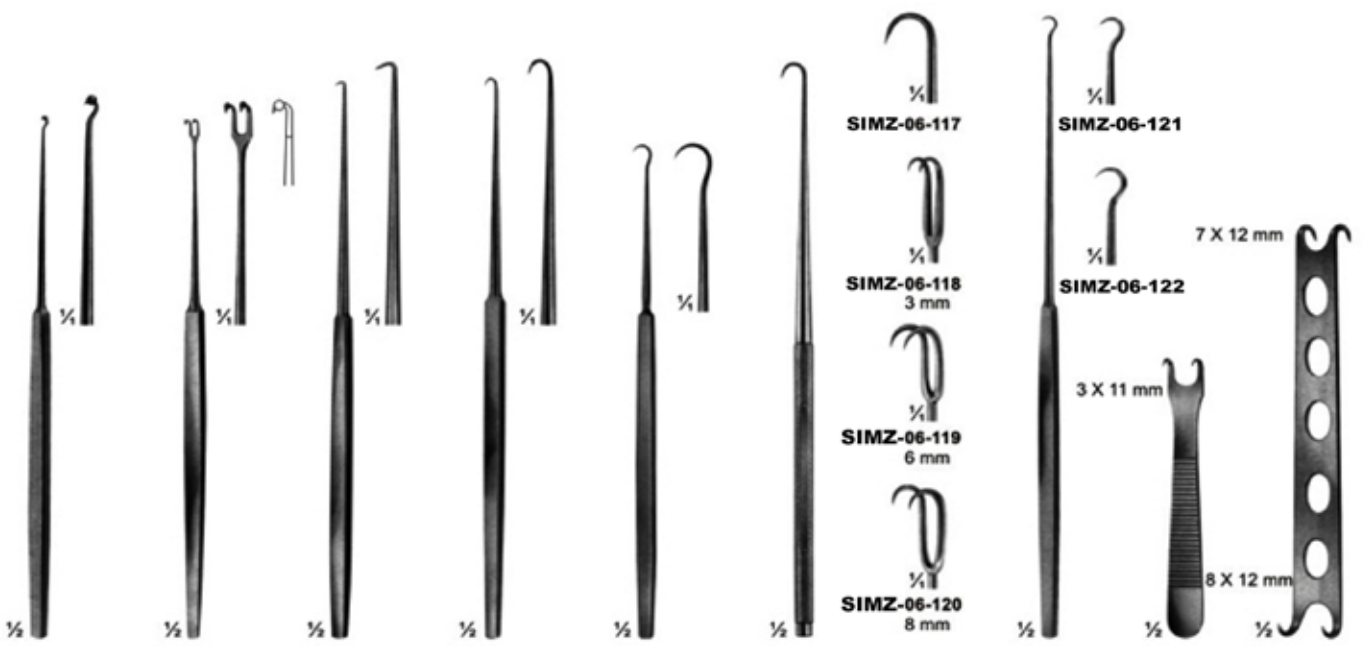

<b>SIMZ-06-112</b> MULLER 150 mm	<b>SIMZ-06-113</b> MULLER 150 mm	<b>SIMZ-06-114</b> COTTLE 160 mm	<b>SIMZ-06-115</b> COTTLE 160 mm	<b>SIMZ-06-116</b> JAEGER 135 mm	<b>SIMZ-06-117 - 120</b> JOSEPH 165 mm	<b>SIMZ-06-121 - 122</b> GILLIES 180 mm	<b>SIMZ-06-123</b> KILNER sharp 80 mm	<b>SIMZ-06-124</b> CONVERSE blunt 120 mm
--	--	--	--	--	--	---	--	---

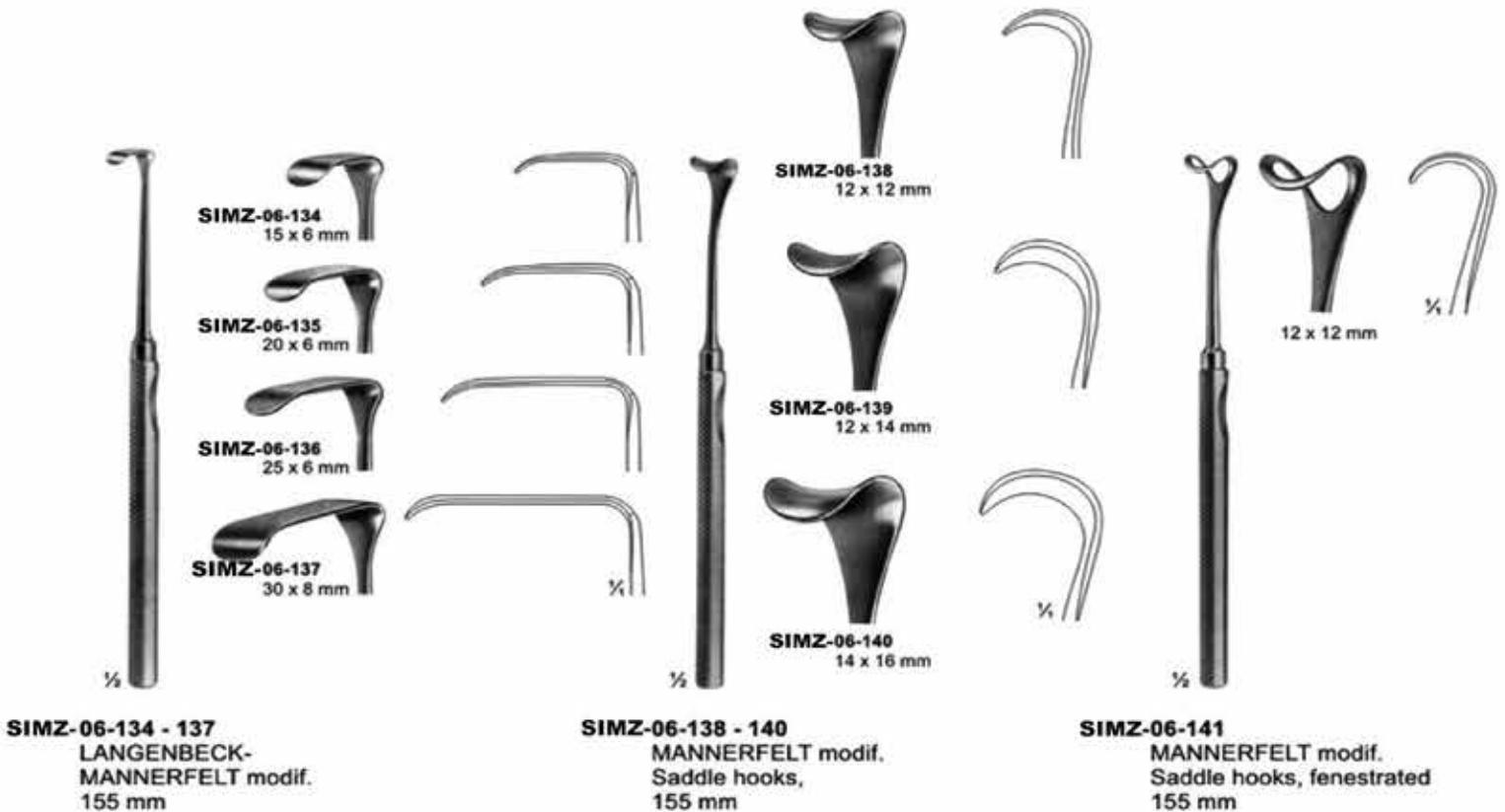
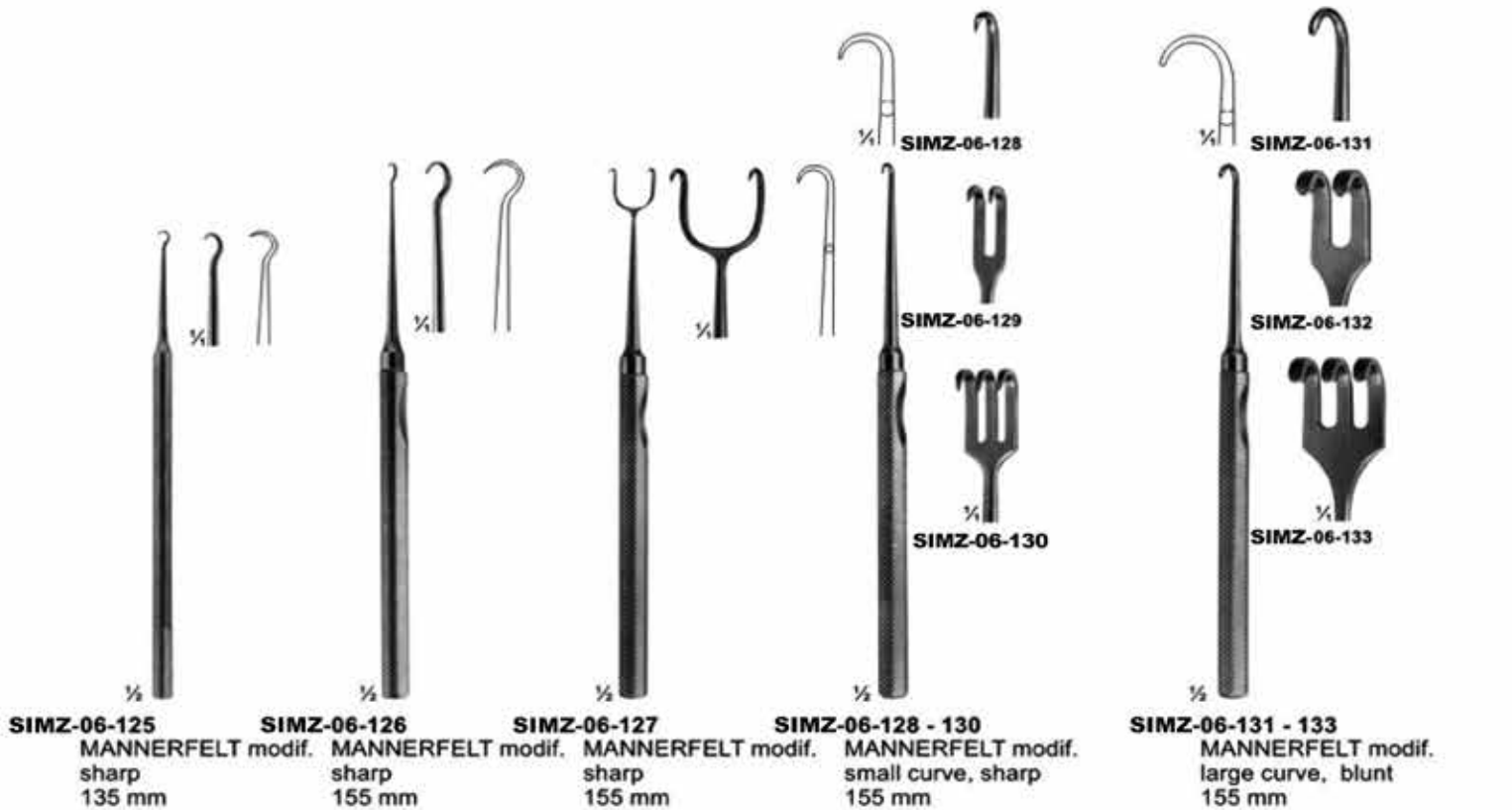



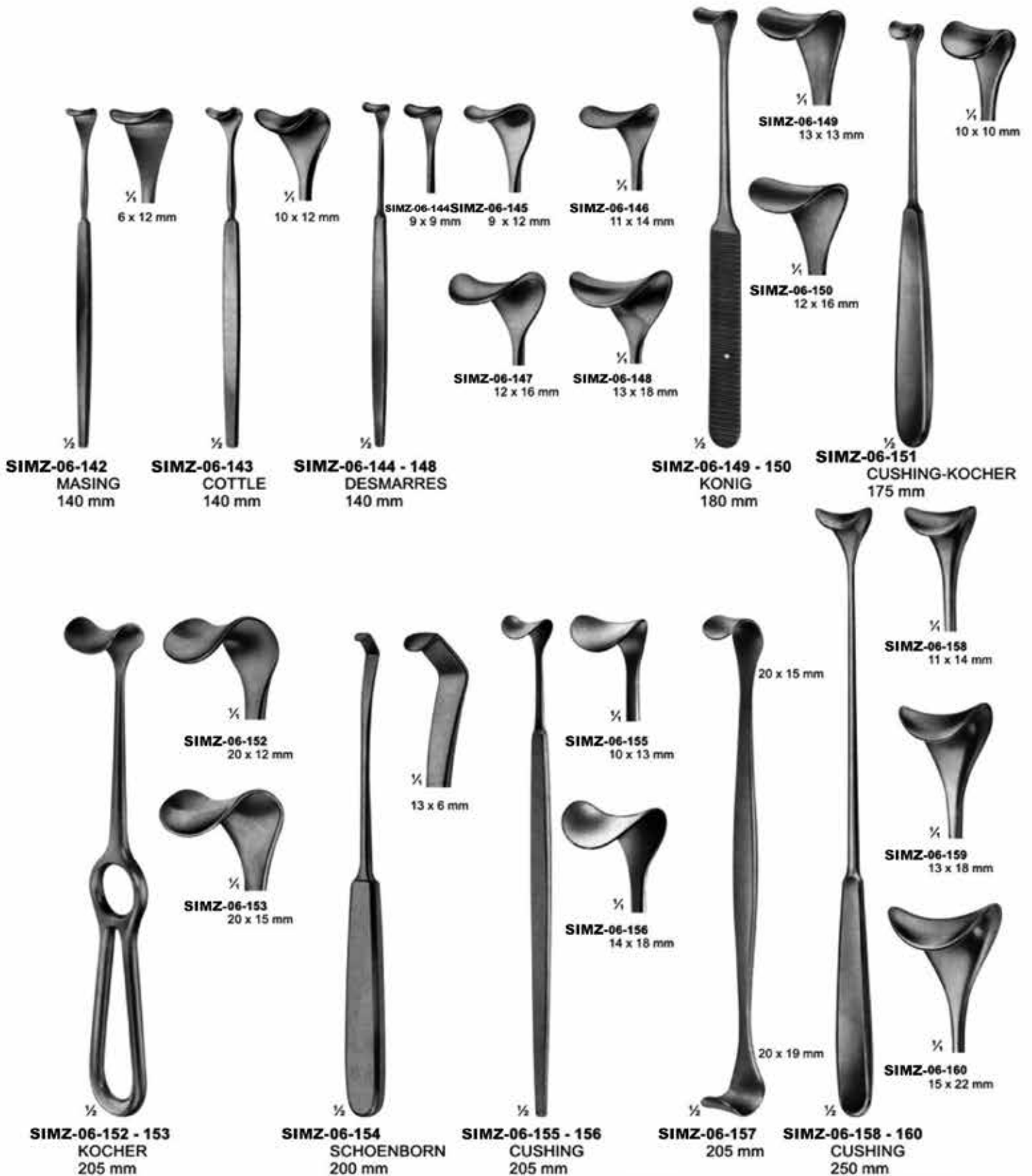



**SIMZ-06-161 - 163**  
ROUX  
Set  
165 mm

**SIMZ-06-161**  
23 x 30 mm

**SIMZ-06-162**  
28 x 38 mm

**SIMZ-06-163**  
33 x 45 mm



**SIMZ-06-164 - 165**  
ROUX

**SIMZ-06-164**  
25 x 29 mm  
150 mm

**SIMZ-06-165**  
30 x 38 mm  
160 mm



**SIMZ-06-166**  
CZERNY  
175 mm

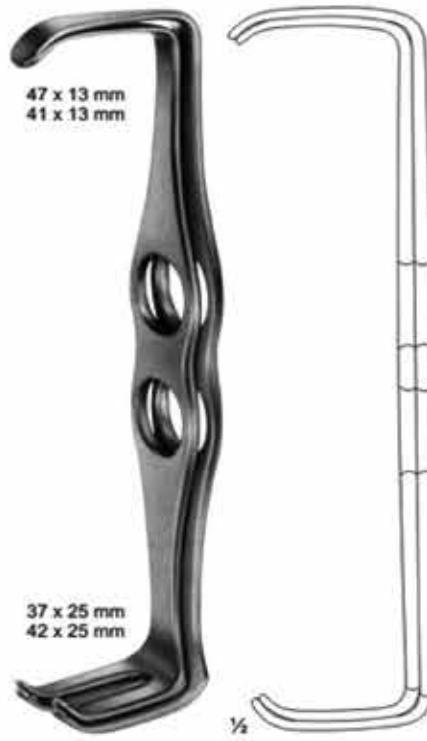

**SIMZ-06-167**  
MATHIEU  
200 mm



**SIMZ-06-168**  
US-ARMY  
220 mm



**MZ-06-169 - 06-170**  
**BABY-SENN-MILLER**  
 155 mm

**SIMZ-06-171**  
**SENN-MILLER**  
 165 mm

**SIMZ-06-172**  
**COLLIN-HARTMANN**  
 150 mm

**STERBERG**  
**SIMZ-06-173** 120 mm  
**SIMZ-06-174** 130 mm  
**SIMZ-06-175** 135 mm  
**SIMZ-06-176** 140 mm

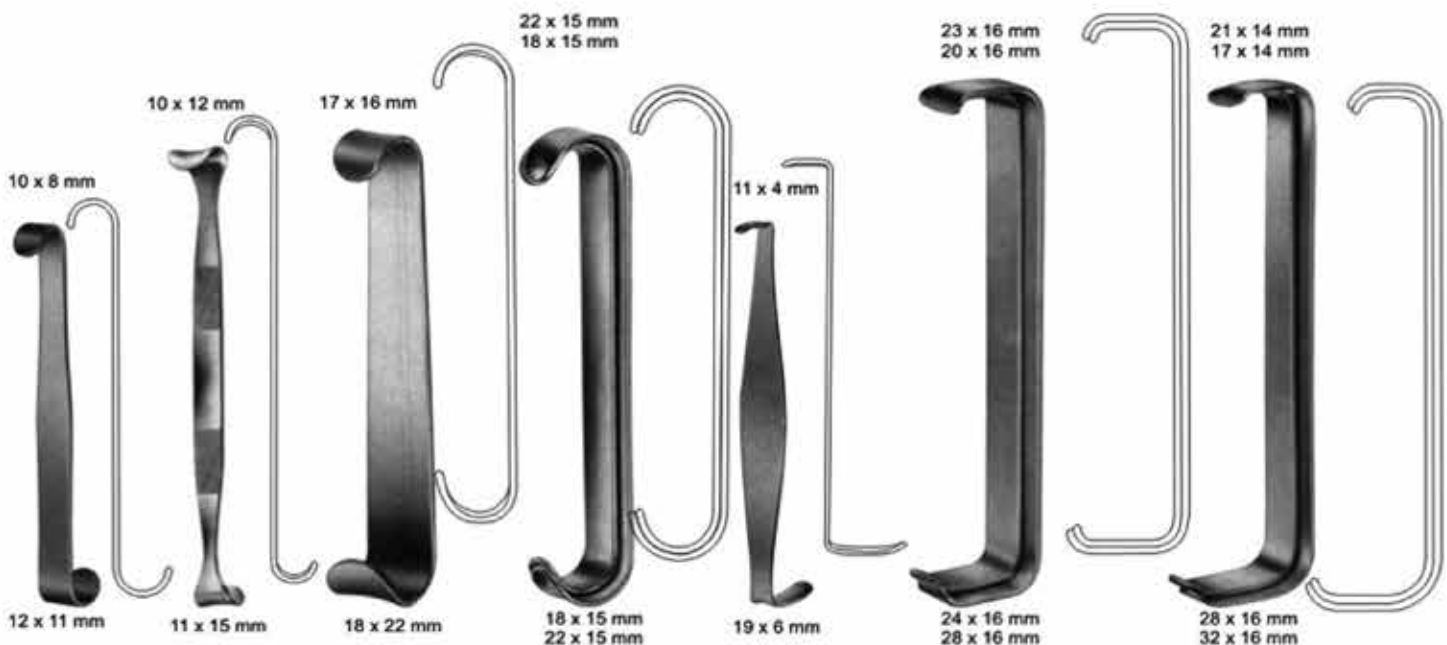

**SIMZ-06-177**  
**LUER**  
 110 mm

**SIMZ-06-178**  
**ROSE**  
 130 mm

**SIMZ-06-179**  
**BABY-ROUX**  
 135 mm

**SIMZ-06-180**  
**PARKER**  
 135 mm

**SIMZ-06-181**  
**CRILE**  
 110 mm

**SIMZ-06-182**  
**FARABEUF**  
 150 mm

**SIMZ-06-183**  
**COLLIN**  
 150 mm



**SIMZ-06-184**  
KOCHER  
sharp  
205 mm



**SIMZ-06-185**  
KOCHER  
sharp  
220 mm



**SIMZ-06-186**  
KOCHER  
sharp  
220 mm



**SIMZ-06-187**  
VOLKMANN  
blunt  
220 mm



**SIMZ-06-188**  
VOLKMANN  
sharp  
220 mm



**SIMZ-06-189 - 06-196**  
VOLKMANN  
225 mm

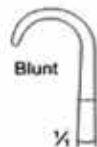
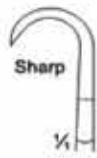

**SIMZ-06-189**  
9 x 8 mm



**SIMZ-06-190**  
9 x 13 mm



**SIMZ-06-191**  
9 x 19 mm



**SIMZ-06-192**  
9 x 29 mm



**SIMZ-06-193**  
8,5 x 8 mm



**SIMZ-06-194**  
8,5 x 13 mm



**SIMZ-06-195**  
8,5 x 19 mm



**SIMZ-06-196**  
8,5 x 29 mm

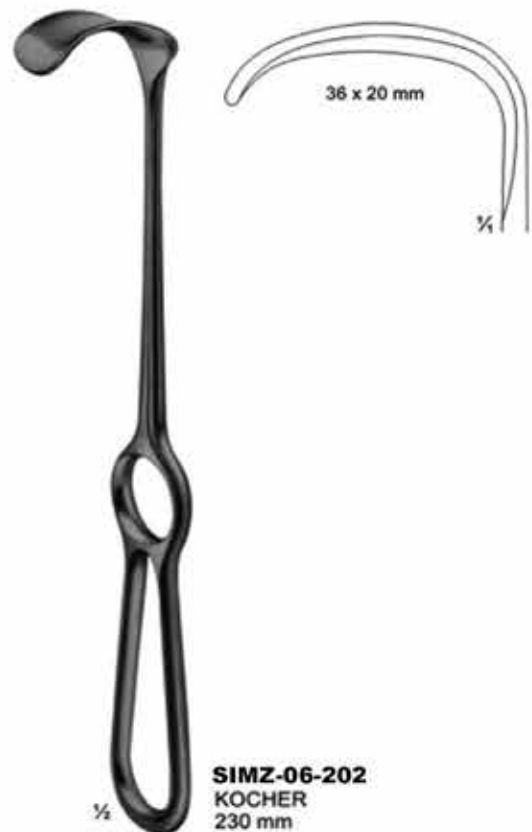
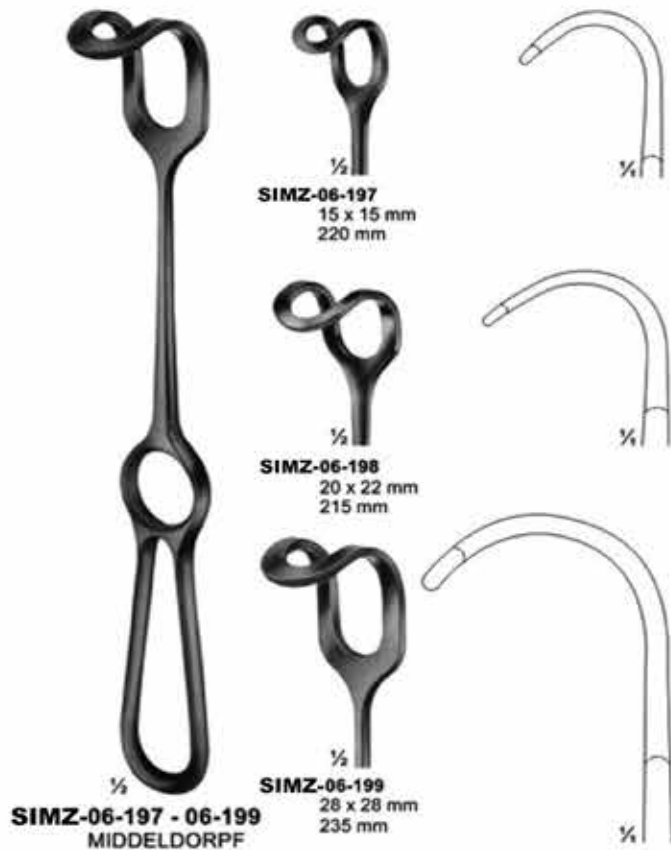



**SIMZ-06-203-06-209**  
BRUNNER  
275 mm

- SIMZ-06-203** 80 x 20
- SIMZ-06-204** 100 x 25
- SIMZ-06-205** 120 x 25
- SIMZ-06-206** 130 x 30
- SIMZ-06-207** 140 x 30
- SIMZ-06-208** 160 x 30
- SIMZ-06-209** 180 x 30



Handle arrangement verriable

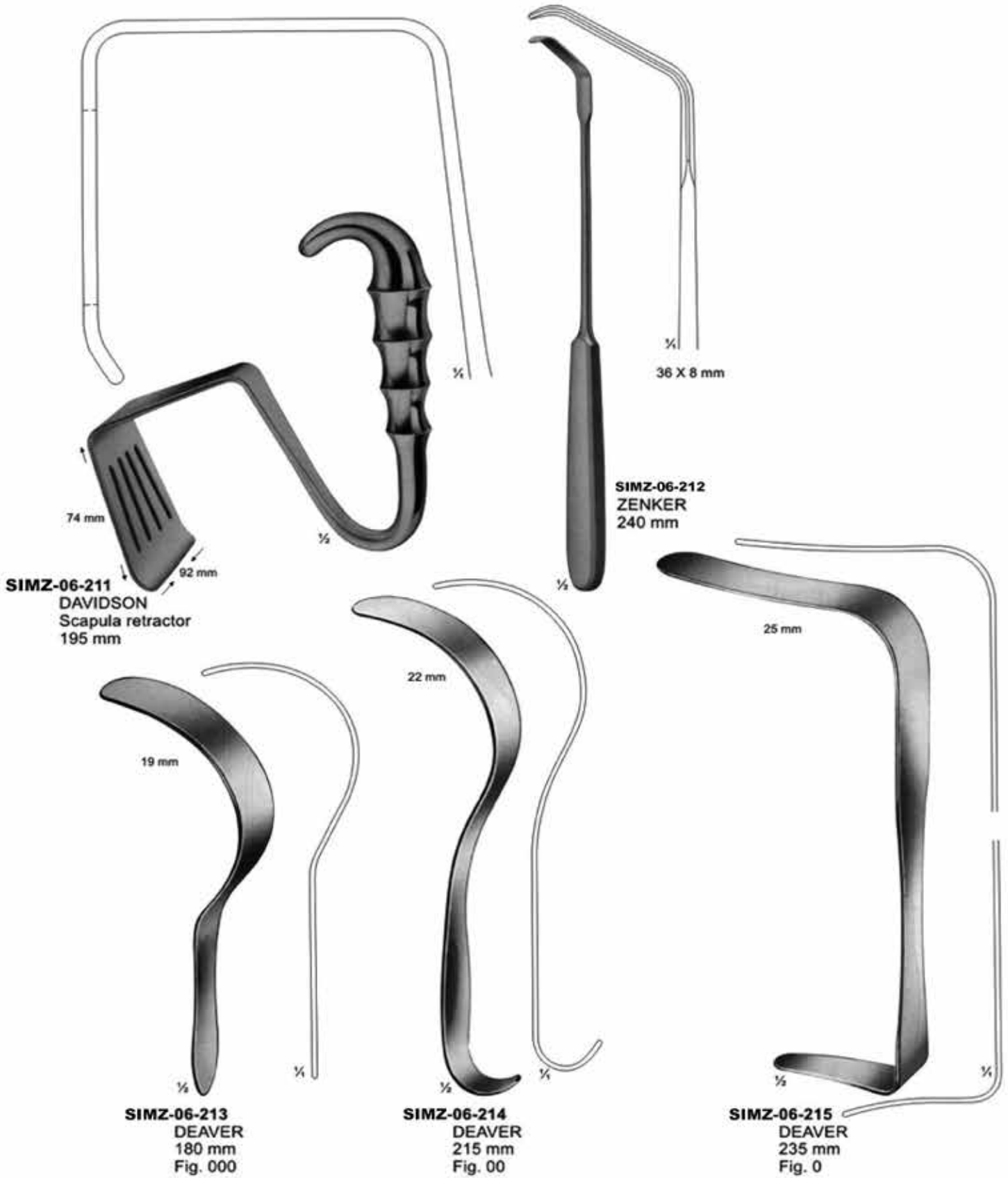







width of blades  
35 mm, 45 mm, 60 mm

length of blades

62 mm	<b>SIMZ-06-218 , 06-222 , 06-226</b>
92 mm	<b>SIMZ-06-219 , 06-223 , 06-227</b>
122 mm	<b>SIMZ-06-220 , 06-224 , 06-228</b>
160 mm	<b>SIMZ-06-221 , 06-225</b>

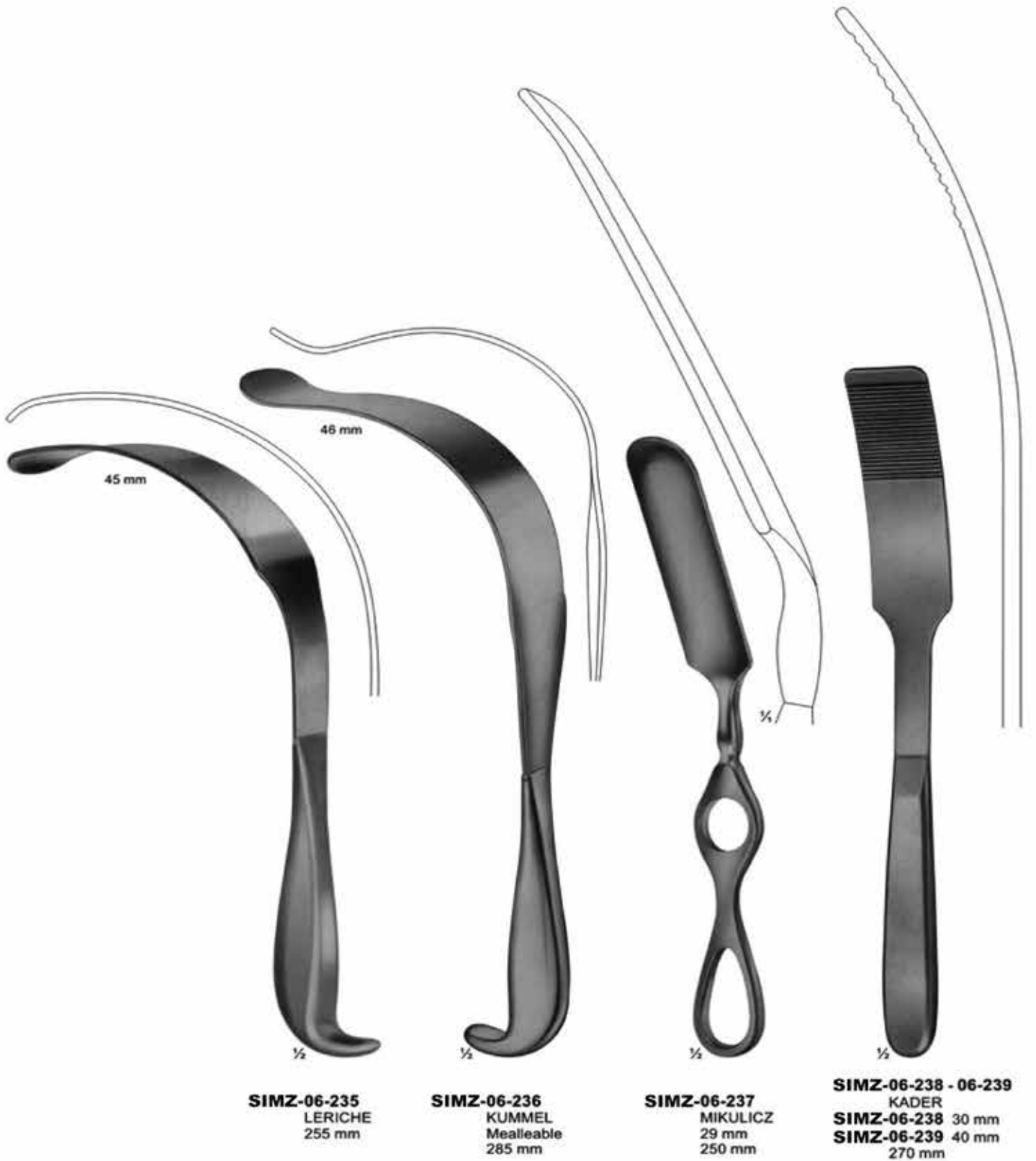

**SIMZ-06-235**  
LERICHE  
255 mm

**SIMZ-06-236**  
KUMMEL  
Mealleable  
285 mm

**SIMZ-06-237**  
MIKULICZ  
29 mm  
250 mm

**SIMZ-06-238 - 06-239**  
KADER  
**SIMZ-06-238** 30 mm  
**SIMZ-06-239** 40 mm  
270 mm



**SIMZ-06-240**  
WEITLANER  
sharp  
130 mm

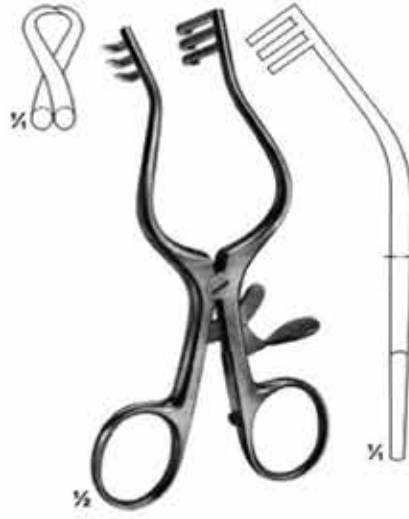

**SIMZ-06-241**  
WULLSTEIN  
sharp  
130 mm

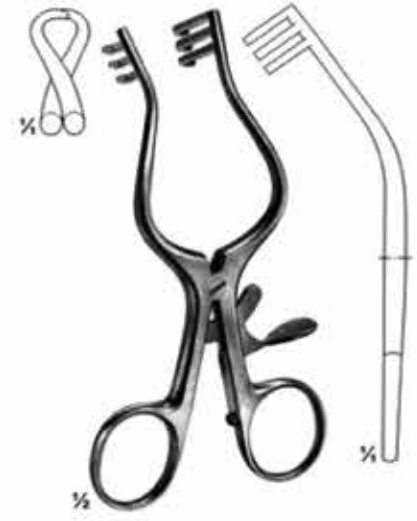

**SIMZ-06-242**  
WULLSTEIN  
blunt  
130 mm



**SIMZ-06-243**  
WEITLANER  
sharp  
165 mm



**SIMZ-06-244**  
PLESTER  
blunt  
110 mm



**SIMZ-06-245**  
PERKINS  
blunt  
130 mm



**SIMZ-06-246**  
**JOLL ( FRIEDMAN )**  
 Thyroid- and vaginal retractor  
 155 mm



**SIMZ-06-247**  
**JACKSON BURROWS**  
 Retractor, blunt  
 185 mm



**SIMZ-06-248**  
**GELPI**  
 Vaginal retractor  
 135 mm

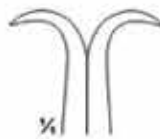

**SIMZ-06-249**  
**GELPI**  
 Skin- and vaginal retractor  
 175 mm

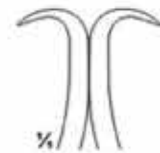

**SIMZ-06-250**  
**DE BAKEY**  
 Femur retractor  
 145 mm



**SIMZ-06-251**  
CLOWARD  
155 mm



**SIMZ-06-252**  
CLOWARD  
135 mm



**SIMZ-06-253**  
INGE  
170 mm

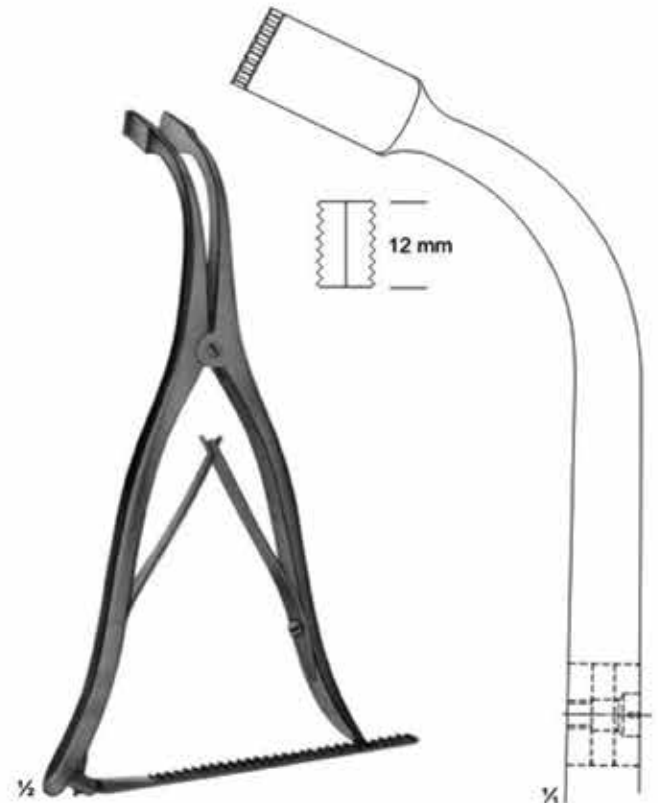

**SIMZ-06-254**  
INGE  
275 mm



**SIMZ-06-255**  
GOSSET  
Blades: 38 mm deep



**SIMZ-06-256**  
HERTZLER  
Blades 20 X 25 mm



**SIMZ-06-257**  
BALFOUR-BABY  
Lateral blades 27 mm deep  
Center blade 21x24 mm



**SIMZ-06-258**  
GOSSET  
Blades: 55 mm deep



**SIMZ-06-259**  
GOSSET  
Lateral blades 58 mm deep  
Center blade 59 x 57 mm

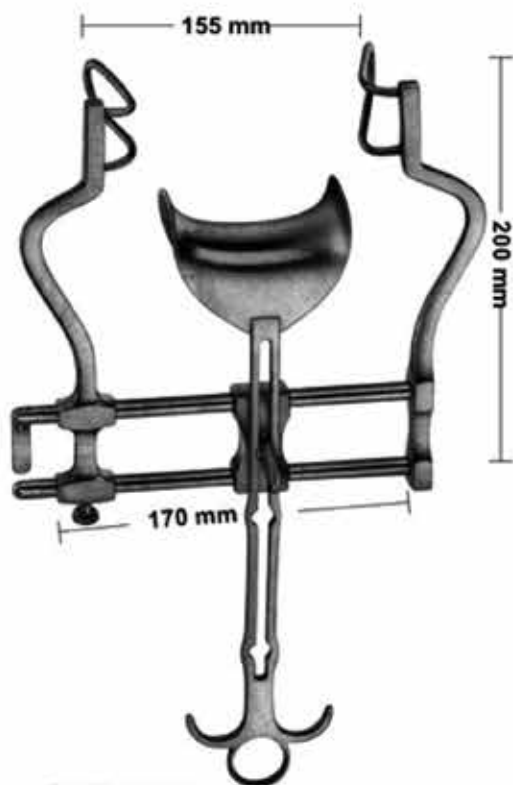

**SIMZ-06-260**  
BALFOUR  
Lateral blades 60 mm deep  
Center blade 47 x 80 mm

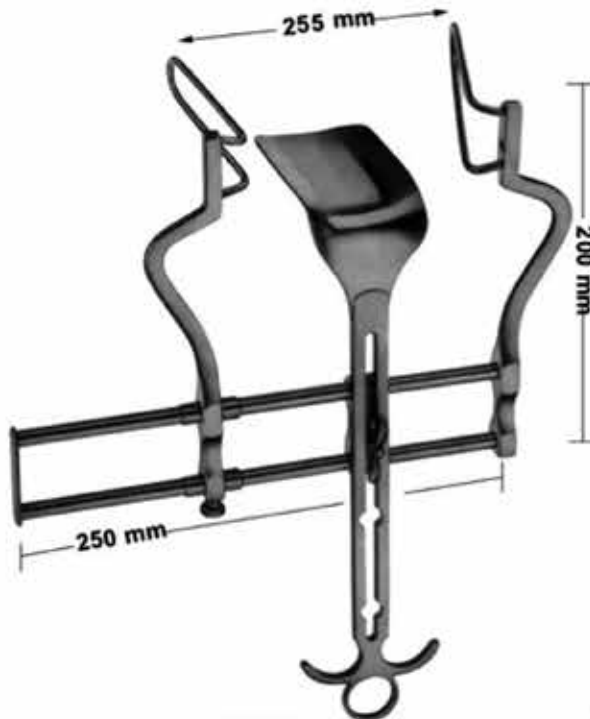

**SIMZ-06-261**  
BALFOUR  
Lateral blades 105 mm deep  
Center blade 107x 59 mm



**SIMZ-06-262**  
Center blade only  
54x80 mm

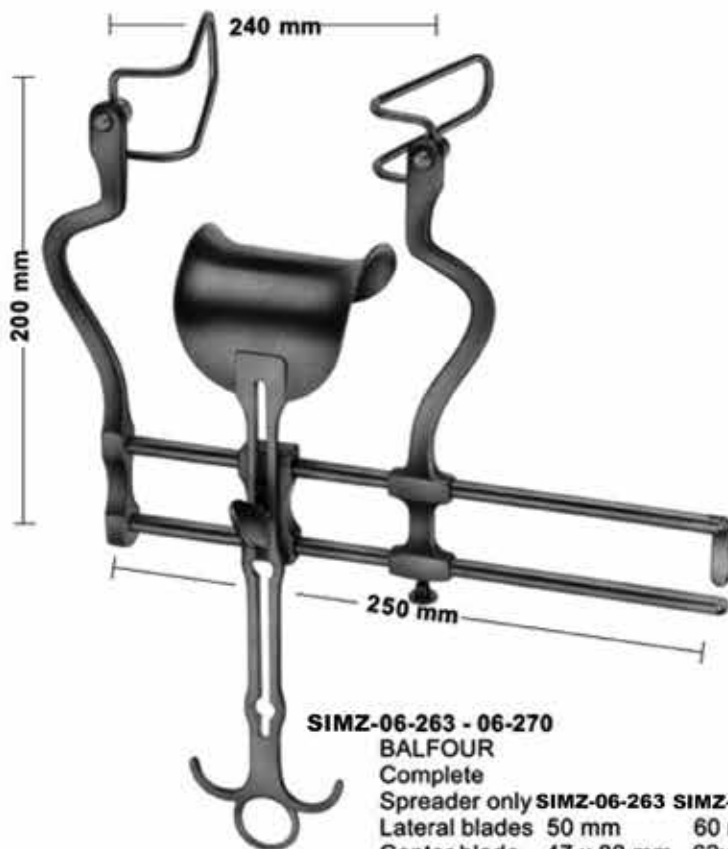

**SIMZ-06-263 - 06-270**  
BALFOUR  
Complete  
Spreader only

	SIMZ-06-263	SIMZ-06-264	SIMZ-06-265	SIMZ-06-266
Lateral blades	50 mm	60 mm	75 mm	90 mm
Center blade	47 x 80 mm	62x76 mm	80x80 mm	80x80 mm



Sales Unit of blades: PR = pair

- SIMZ-06-212** Lateral blades
- SIMZ-06-267** 50 mm deep
- SIMZ-06-268** 60 mm deep
- SIMZ-06-269** 75 mm deep
- SIMZ-06-270** 90 mm deep

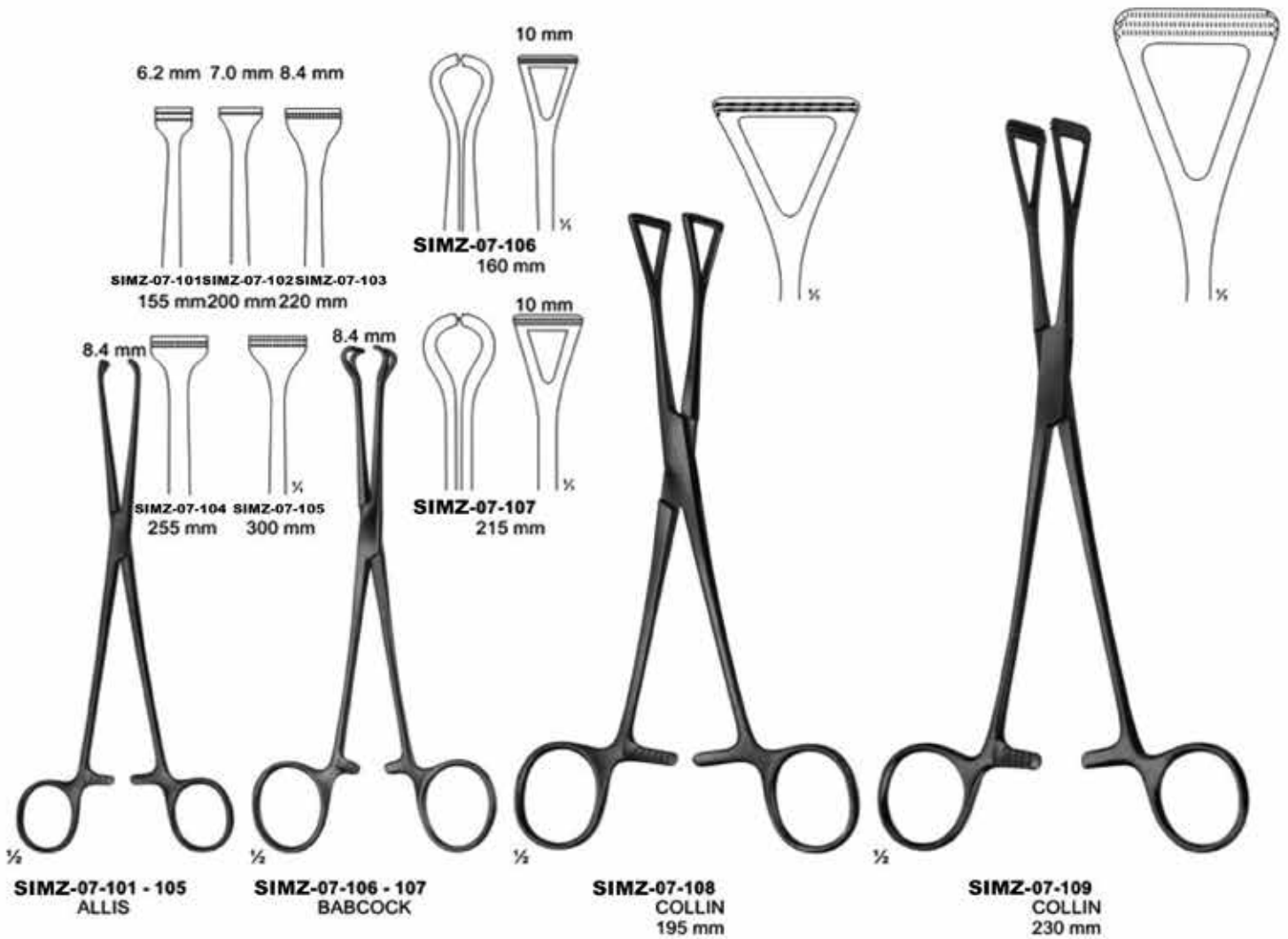



**ATRAUMATA**



**ATRAUMATA**





**SIMZ-07-118**  
 PAYR  
 Intestinal clamp  
 light pattern,  
 for children  
 180 mm

**SIMZ-07-119**  
 PAYR  
 200 mm

**SIMZ-07-120**  
 PAYR  
 275 mm

**SIMZ-07-121**  
 PAYR  
 Pylorus clamp  
 315 mm

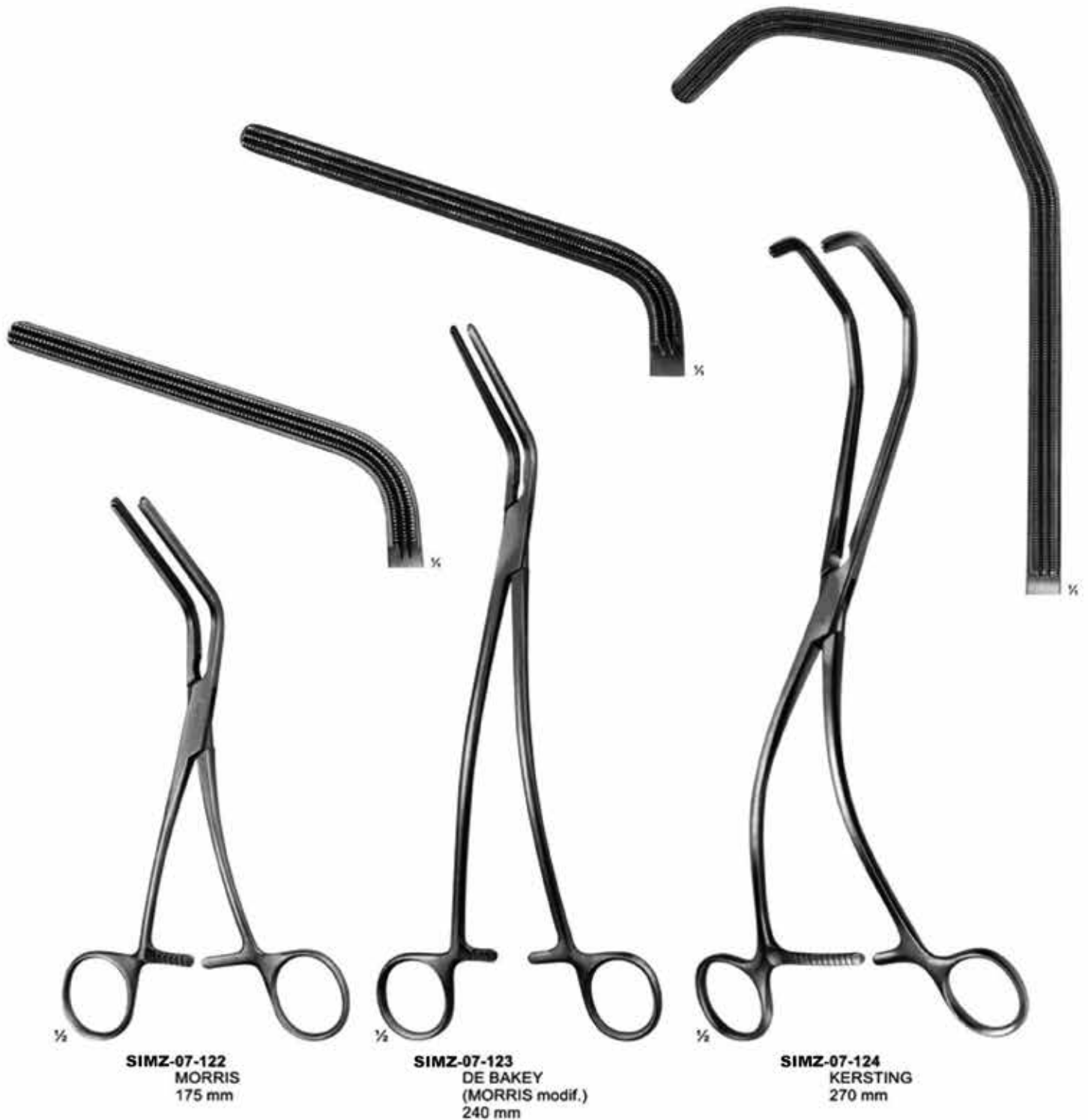



**SIMZ-08-101**  
Martin  
13 cm / 5 1/8"



**SIMZ-08-102**  
SIMS  
160 mm



**SIMZ-08-103**  
Tieck-Halle  
13 cm / 5 1/8"



**SIMZ-08-104**  
Killian

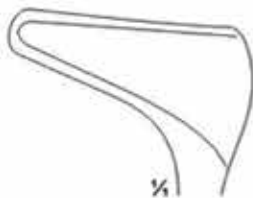

Fig. 1  
14 cm 5 4/8"  
35 mm

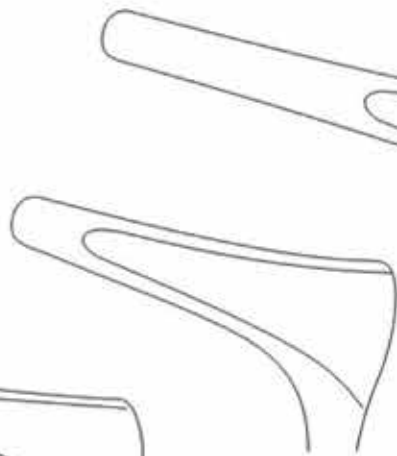

Fig. 2  
14,5 cm / 5 4/8"  
50 mm

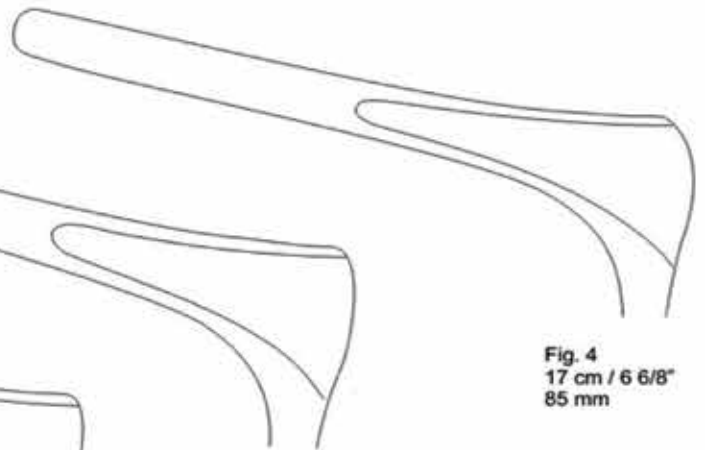

Fig. 3  
16 cm / 6 2/8"  
75 mm

Fig. 4  
17 cm / 6 6/8"  
85 mm



**SIMZ-08-105**  
Cottle

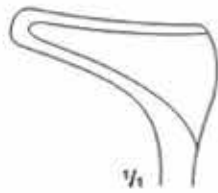

Fig. 1  
13,5 cm / 5 3/8"  
35 mm



Fig. 2  
14 cm / 5 4/8"  
50 mm



Fig. 3  
16 cm / 6 2/8"  
75 mm



Fig. 4  
16 cm / 6 2/8"  
85 mm



**SIMZ-08-106**  
Goldsmith (Thudichum)  
6,5 cm / 2 4/8"



Fig. 1  
21,0 x 9,5 mm



Fig. 2  
21,0 x 10,5 mm



Fig. 3  
21,0 x 11,5 mm



**SIMZ-08-107**  
Mod. Wien 2  
13,5 cm / 5 1/8"

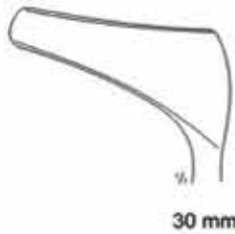

Fig. 1  
30 mm



**SIMZ-08-108**  
Hartmann-Halle  
16 cm / 6 1/8"



Fig. 1  
27 mm



Fig. 2  
31 mm

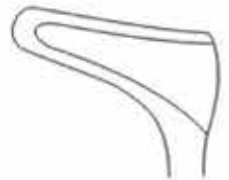

Fig. 3  
35 mm



**SIMZ-08-109**  
IVES-FANSLER  
Anuscopy  
145 mm  
Ø24mm



**SIMZ-08-110**  
KELLY  
Sphincteroscope  
160 mm  
Ø21mm



**SIMZ-08-111**  
KELLY  
Sphincteroscope  
160 mm  
Ø27mm

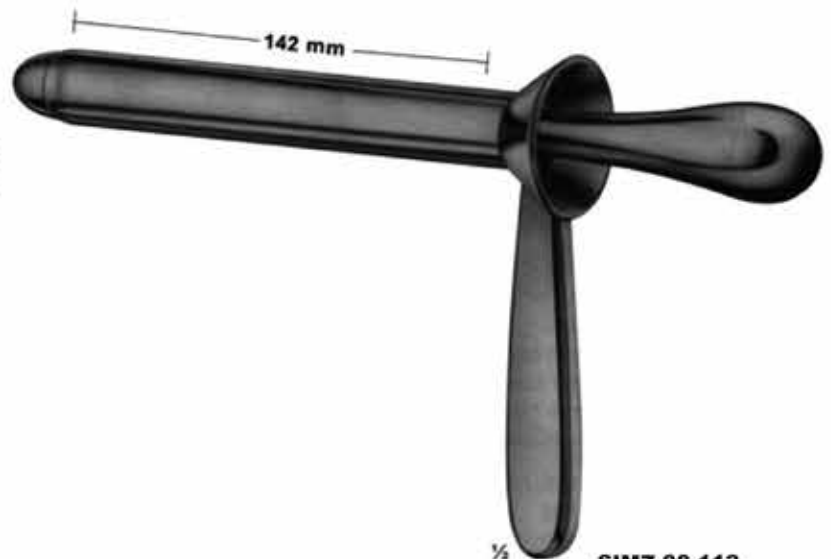

**SIMZ-08-112**  
KELLY  
Proctoscope  
140 mm  
Ø22mm

## ATRAUMATA

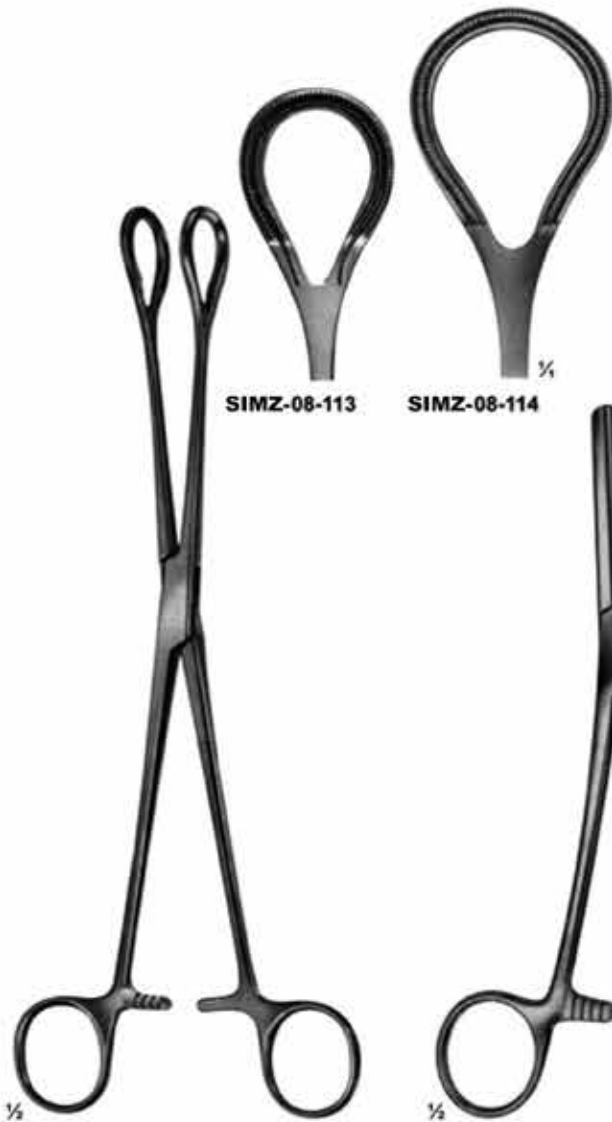

**SIMZ-08-113 - 08-114**  
250 mm  
08-114  
270 mm

## Pressure Clamp



**SIMZ-08-115 - 08-116**  
FERGUSSON  
200 mm



**SIMZ-08-117**  
RUDD  
Haemorrhoidal ligator  
with loading  
attachment and 100  
ligature rubber rings  
315 mm



**SIMZ-08-118**  
LOWER  
180 mm



**SIMZ-08-119**  
LAHEY ( SWEET )  
190 mm



**SIMZ-08-120**  
LAHEY  
220 mm



**SIMZ-08-121**  
DESJARDINS  
Gall duct-and cystic forceps  
210 mm



**SIMZ-08-122**  
NISSEN  
Gall duct-and cystic forceps  
215 mm





**Charr.  
(French)**  
 08-123 8  
 08-124 9  
 08-125 10  
 08-126 11  
 08-127 12  
 08-128 13  
 08-129 14  
 08-130 15  
 08-131 16  
 08-132 17  
 08-133 18  
 08-134 19  
 08-135 20  
 08-136 21  
 08-137 22  
 08-138 23  
 08-139 24  
 08-140 25  
 08-141 26  
 08-142 27  
 08-143 28  
 08-144 29  
 08-145 30

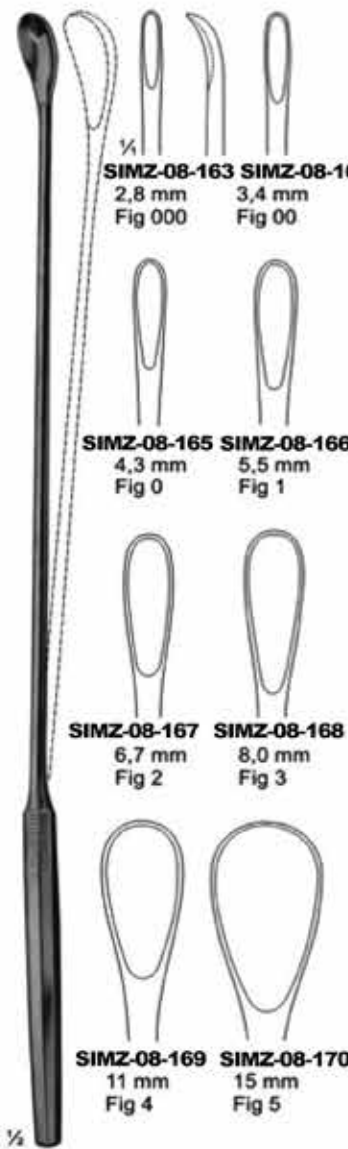
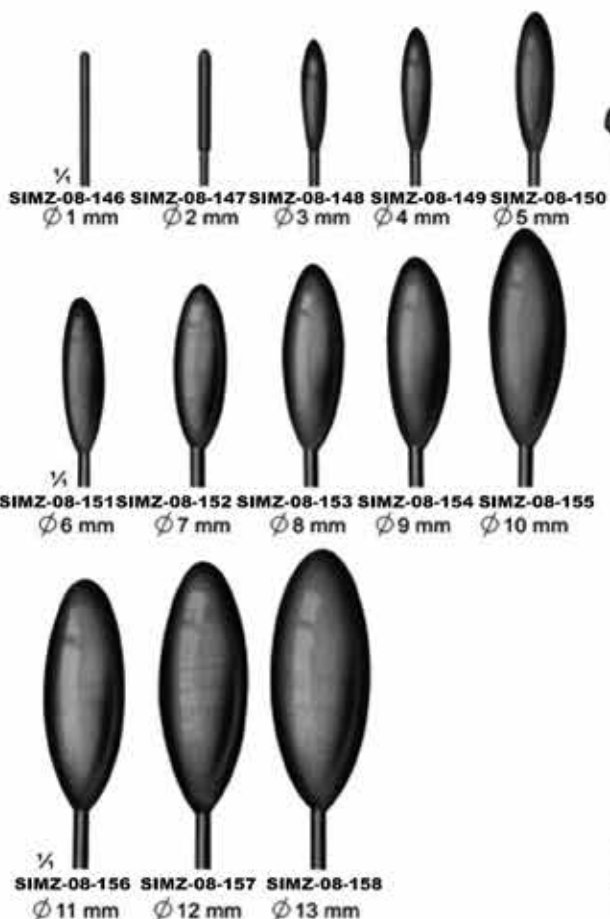

**SIMZ-08-123 - 08-145** **SIMZ-08-146 - 08-158**  
**DITTEL** **BAKES**  
 Metall bougies and Common bile duct  
 dilating sounds, stiff dilators, malleable  
 345 mm **SIMZ-08-146 - 08-150** 315 mm  
**SIMZ-08-151 - 08-158** 320 mm

**SIMZ-08-159 - 08-162** **SIMZ-08-163 - 08-170**  
**DESJARDINS** **LUER-KOERTE modif**  
 Probe and catch with flexible shaft with malleable shaft  
 300 mm 310 mm

# Gall Stone Forceps



**SIMZ-08-171**  
BLAKE  
205 mm



**SIMZ-08-172**  
BLAKE  
205 mm

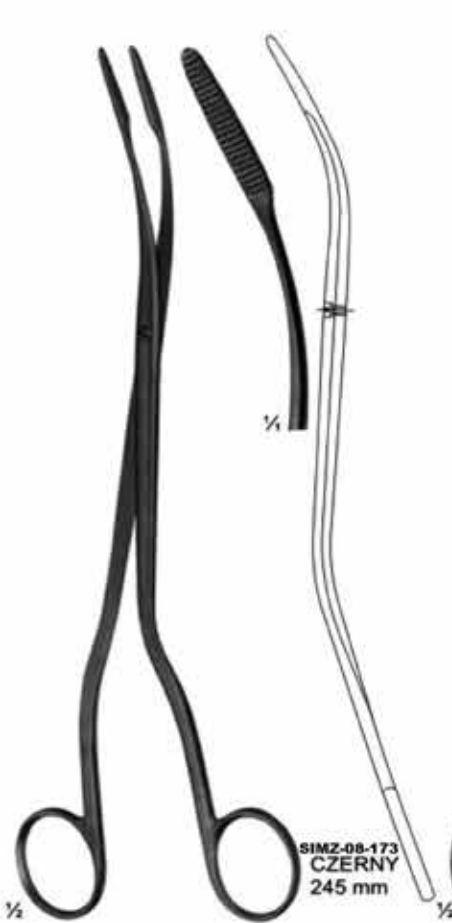

**SIMZ-08-173**  
CZERNY  
245 mm

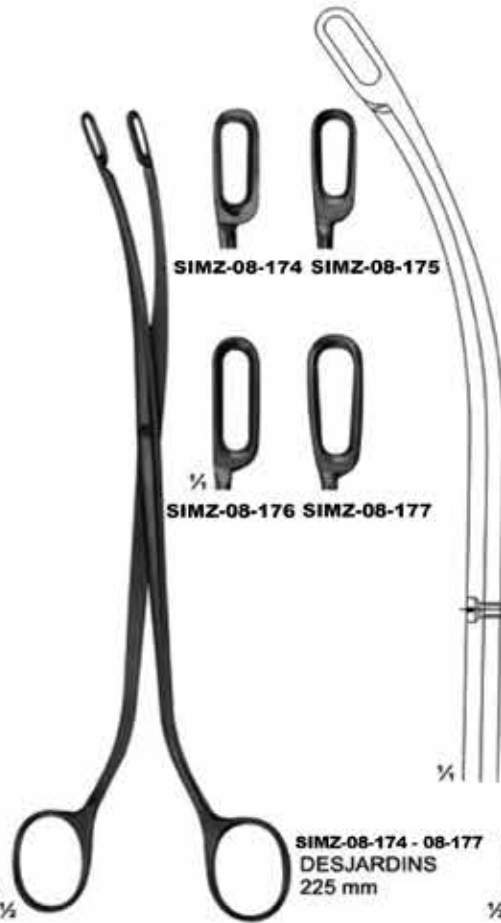

**SIMZ-08-174 - 08-177**  
DESJARDINS  
225 mm

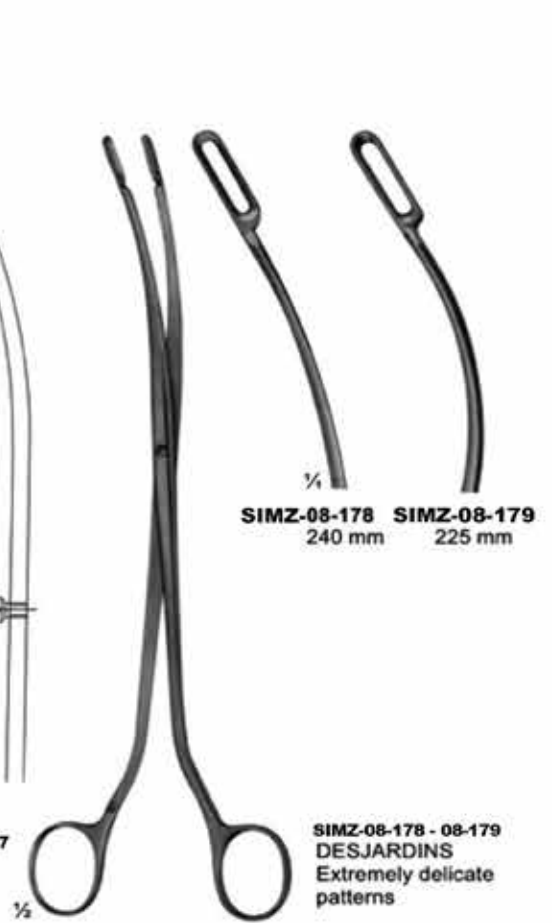

**SIMZ-08-178 - 08-179**  
DESJARDINS  
Extremely delicate  
patterns

**SIMZ-08-174 SIMZ-08-175**

**SIMZ-08-176 SIMZ-08-177**

**SIMZ-08-178 SIMZ-08-179**  
240 mm 225 mm

## ATRAUMATA

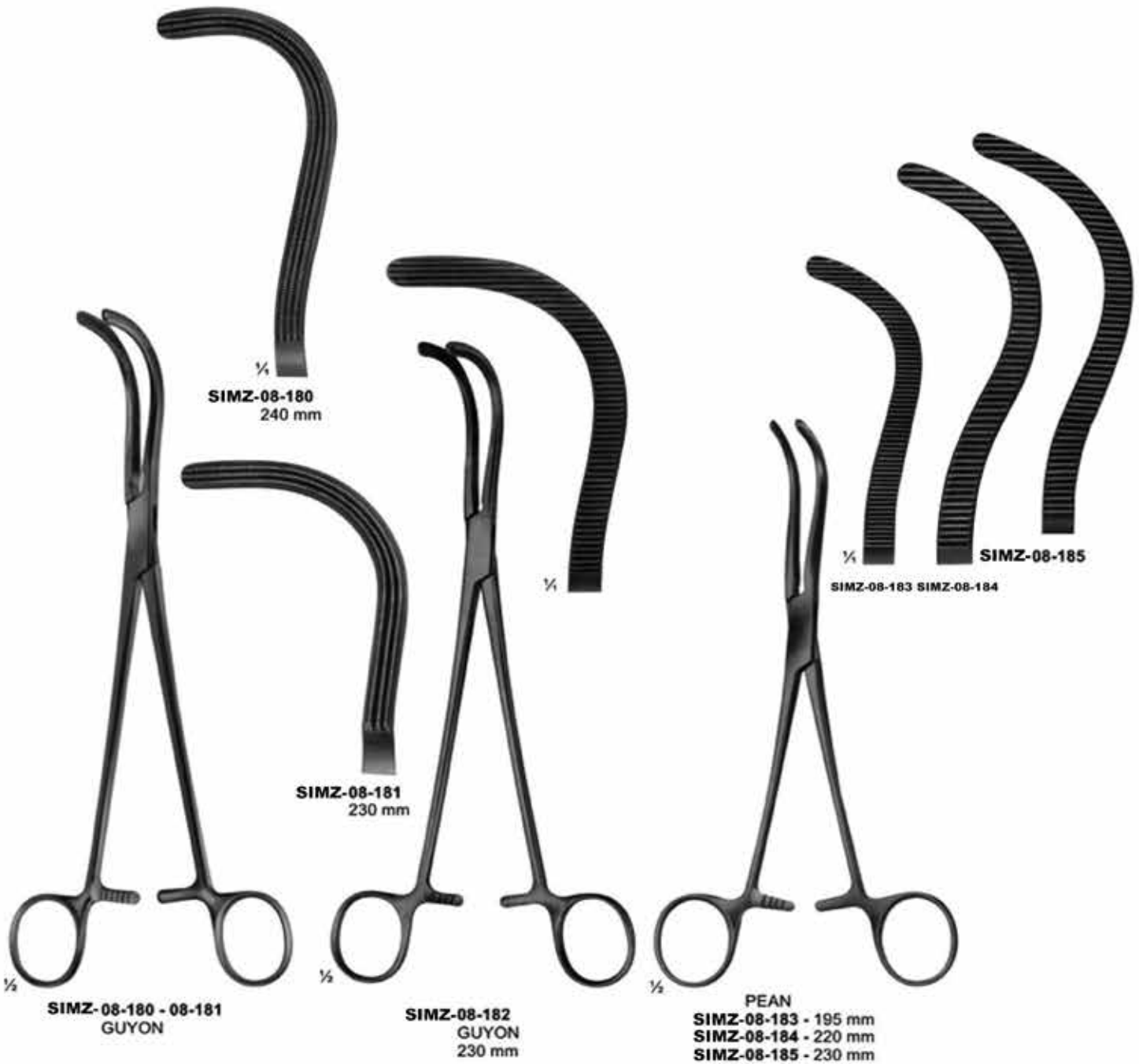



SIMZ-08-186



SIMZ-08-187



SIMZ-08-188



SIMZ-08-189



SIMZ-08-190



SIMZ-08-191



SIMZ-08-192



SIMZ-08-186 - 08-189  
RANDALL  
225 mm



SIMZ-08-190 - 08-192  
RANDALL  
190 mm



**SIMZ-09-101**  
JUDD-MASSON  
Bladder and suprapubic  
retractor



**SIMZ-09-102**  
MILLIN  
Center bladder for  
retro pubic prostatectomy



**SIMZ-09-103**  
MILLIN  
Bladder retractor, complete  
105X45 mm



**SIMZ-09-104**  
LEGUEU  
Bladder retractor  
Center blade  
80 x 31 mm



**SIMZ-09-105**  
KOCHER  
Bladder spatula  
235 mm



**SIMZ-09-106**  
KLIMA ROSEGGER  
35 X 1,8 mm  
Sternal puncture needle

**SIMZ-09-107**  
Universal trocar  
with 4 tips

**NELSON**

**SIMZ-09-113 - 116**  
Inside dime. Outside dime

<b>SIMZ-09-113</b>	2,2 mm	3,0 mm
<b>SIMZ-09-114</b>	3,0 mm	4,0 mm
<b>SIMZ-09-115</b>	4,0 mm	5,0 mm
<b>SIMZ-09-116</b>	5,0 mm	6,0 mm

for abdominal puncture,  
with stop-cock and lateral  
drain

**SIMZ-09-108 - 112**  
Inside diam. Outside diam

<b>SIMZ-09-108</b>	2,2 mm	3,0 mm
<b>SIMZ-09-109</b>	3,0 mm	4,0 mm
<b>SIMZ-09-110</b>	4,0 mm	5,0 mm
<b>SIMZ-09-111</b>	5,0 mm	6,0 mm
<b>SIMZ-09-112</b>	5,5 mm	6,5 mm

for hydrocele and abdominal  
puncture



**SIMZ-09-117 - 118**  
Inside diam. Outside diam

<b>SIMZ-09-117</b>	6,5 mm	8,0 mm
<b>SIMZ-09-118</b>	9,0 mm	10,0 mm

Empyema trocar  
BUELEU

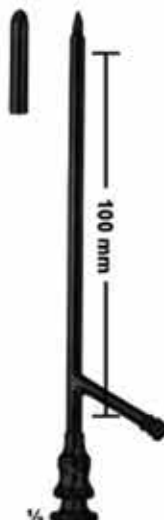

**SIMZ-09-119 - 122**  
Inside diam. Outside diam

<b>SIMZ-09-119</b>	3,0 mm	4,0 mm
<b>SIMZ-09-120</b>	3,6 mm	4,6 mm
<b>SIMZ-09-121</b>	4,3 mm	5,3 mm
<b>SIMZ-09-122</b>	5,0 mm	6,0 mm

**SIMZ-Gall bladder trocars. OCHSNER**



**SIMZ-09-123**  
PIERCE  
Antrum trocar  
Ø4,0 mm



**SIMZ-09-124**  
COAKLEY  
Antrum trocar  
3,0 mm



**SIMZ-10-101**  
COLLIN  
for children  
53 x 10 mm



**SIMZ-10-102 - 105**  
COLLIN

<b>SIMZ-10-102</b>	100/90mm	28 mm
<b>SIMZ-10-103</b>	100/90mm	32 mm
<b>SIMZ-10-104</b>	105/95mm	35 mm
<b>SIMZ-10-105</b>	115/105mm	40 mm
	Total length/working length	width



**SIMZ-10-106**  
COLLIN  
for virgins  
95/85 x 18 mm



**SIMZ-10-107**  
CUSCO  
for virgins  
75 x 17 mm



**SIMZ-10-108**  
CUSCO  
for virgins  
75 x 17 mm



**SIMZ-10-109 - 111**  
CUSCO

<b>SIMZ-10-109</b>	92X23-25 mm
<b>SIMZ-10-110</b>	100x25-27 mm
<b>SIMZ-10-111</b>	110x27-30 mm

**SIMZ-10-112 - 114**  
GRAVE  
SIMZ-10-112 75X20 mm  
SIMZ-10-113 95X30 mm  
SIMZ-10-114 105X33 mm



**SIMZ-10-115 - 116**  
PEDERSON  
SIMZ-10-115 100X22 mm  
SIMZ-10-116 120X25 mm



**SIMZ-10-117 - 118**  
BRIESKY  
SIMZ-10-117 72X25 mm / 77X30 mm 140 mm  
SIMZ-10-118 75X30 mm / 92X38 mm 170 mm



**SIMZ-10-119**  
SIMS  
70 X 26 mm / 75 X 30 mm  
75 X 30 mm / 80 X 35 mm  
80 X 36 mm / 90 X 40 mm  
175 mm



**SIMZ-10-120 - 122**  
SEIDL  
SIMZ-10-120 80X8 mm  
SIMZ-10-121 80X10 mm  
SIMZ-10-122 90X14 mm  
For children and infants  
170 mm



**SIMZ-10-123**  
KRISTELLER  
70X15 mm, ( 170 mm )  
For children



**SIMZ-10-124 - 10-126**  
KRISTELLER  
SIMZ-10-124 70X27 mm  
SIMZ-10-125 75X30 mm  
SIMZ-10-126 90X36 mm  
175 mm





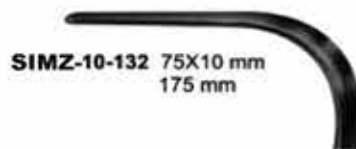

**SIMZ-10-132** 75X10 mm  
175 mm



**SIMZ-10-133** 75X23 mm  
180 mm



**SIMZ-10-134** 80X25 mm  
180 mm



**SIMZ-10-135** 100X32 mm  
185 mm



**SIMZ-10-136** 70X15 mm  
175 mm



**SIMZ-10-137** 70X27 mm  
180 mm

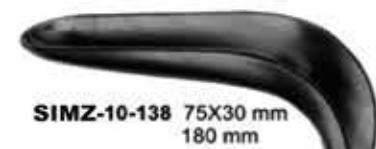

**SIMZ-10-138** 75X30 mm  
180 mm



**SIMZ-10-139** 90X36 mm  
185 mm

**SIMZ-10-127 - 131**  
KRISTELLER  
**SIMZ-10-127** 110X18 mm  
**SIMZ-10-128** 110X20 mm  
**SIMZ-10-129** 110X27 mm  
**SIMZ-10-130** 110X30 mm  
**SIMZ-10-131** 110X36 mm  
 220 mm

**SIMZ-10-132 - 10-135**  
KRISTELLER  
Upper blades

**SIMZ-10-136 - 10-139**  
KRISTELLER  
Lower blades



**SIMZ-10-140**  
60 X 45 mm

**SIMZ-10-141**  
90 X 45 mm

**SIMZ-10-142**  
112 X 45 mm

**SIMZ-10-140 - 143**  
DOYEN  
235 mm

length of blades	width of blades			10-143 - 10-153 DOYEN 240 mm
	35 mm	45 mm	60 mm	
60 mm				
90 mm	<b>SIMZ-10-143</b>	SIMZ-10-146	SIMZ-10-150	
120 mm	<b>SIMZ-10-144</b>	SIMZ-10-147	SIMZ-10-151	
160 mm	<b>SIMZ-10-145</b>	SIMZ-10-148	SIMZ-10-152	
		SIMZ-10-149	SIMZ-10-153	



**SIMZ-10-154**  
JOLL (FRIEDMAN)  
155 mm



**SIMZ-10-155**  
RICHTER  
170 mm



**SIMZ-10-156**  
GELPI  
135 mm



**SIMZ-10-157**  
GELPI  
175 mm



<b>SIMZ-11-101</b>	1	mm	<b>SIMZ-11-123</b>	23	mm
<b>SIMZ-11-102</b>	2	mm	<b>SIMZ-11-124</b>	24	mm
<b>SIMZ-11-103</b>	3	mm	<b>SIMZ-11-125</b>	25	mm
<b>SIMZ-11-104</b>	4	mm	<b>SIMZ-11-126</b>	26	mm
<b>SIMZ-11-105</b>	5	mm	<b>SIMZ-11-127</b>	1	½mm
<b>SIMZ-11-106</b>	6	mm	<b>SIMZ-11-128</b>	2	½mm
<b>SIMZ-11-107</b>	7	mm	<b>SIMZ-11-129</b>	3	½mm
<b>SIMZ-11-108</b>	8	mm	<b>SIMZ-11-130</b>	4	½mm
<b>SIMZ-11-109</b>	9	mm	<b>SIMZ-11-131</b>	5	½mm
<b>SIMZ-11-110</b>	10	mm	<b>SIMZ-11-132</b>	6	½mm
<b>SIMZ-11-111</b>	11	mm	<b>SIMZ-11-133</b>	7	½mm
<b>SIMZ-11-112</b>	12	mm	<b>SIMZ-11-134</b>	8	½mm
<b>SIMZ-11-113</b>	13	mm	<b>SIMZ-11-135</b>	9	½mm
<b>SIMZ-11-114</b>	14	mm	<b>SIMZ-11-136</b>	10	½mm
<b>SIMZ-11-115</b>	15	mm	<b>SIMZ-11-137</b>	11	½mm
<b>SIMZ-11-116</b>	16	mm	<b>SIMZ-11-138</b>	12	½mm
<b>SIMZ-11-117</b>	17	mm	<b>SIMZ-11-139</b>	13	½mm
<b>SIMZ-11-118</b>	18	mm	<b>SIMZ-11-140</b>	14	½mm
<b>SIMZ-11-119</b>	19	mm	<b>SIMZ-11-141</b>	15	½mm
<b>SIMZ-11-120</b>	20	mm	<b>SIMZ-11-142</b>	16	½mm
<b>SIMZ-11-121</b>	21	mm	<b>SIMZ-11-143</b>	17	½mm
<b>SIMZ-11-122</b>	22	mm			

**SIMZ-11-101 - 143**  
HEGAR  
with very conical point  
185 mm



<b>SIMZ-11-144</b>	1+2	mm
<b>SIMZ-11-145</b>	3+4	mm
<b>SIMZ-11-146</b>	5+6	mm
<b>SIMZ-11-147</b>	7+8	mm
<b>SIMZ-11-148</b>	9+10	mm
<b>SIMZ-11-149</b>	11+12	mm
<b>SIMZ-11-150</b>	13+14	mm
<b>SIMZ-11-151</b>	15+16	mm
<b>SIMZ-11-152</b>	17+18	mm

**SIMZ-11-144 - 152**  
HEGAR  
205 mm



**SIMZ-11-153**  
HEGAR  
Uterine dilator set, in canvas  
roll with 8 dilators.

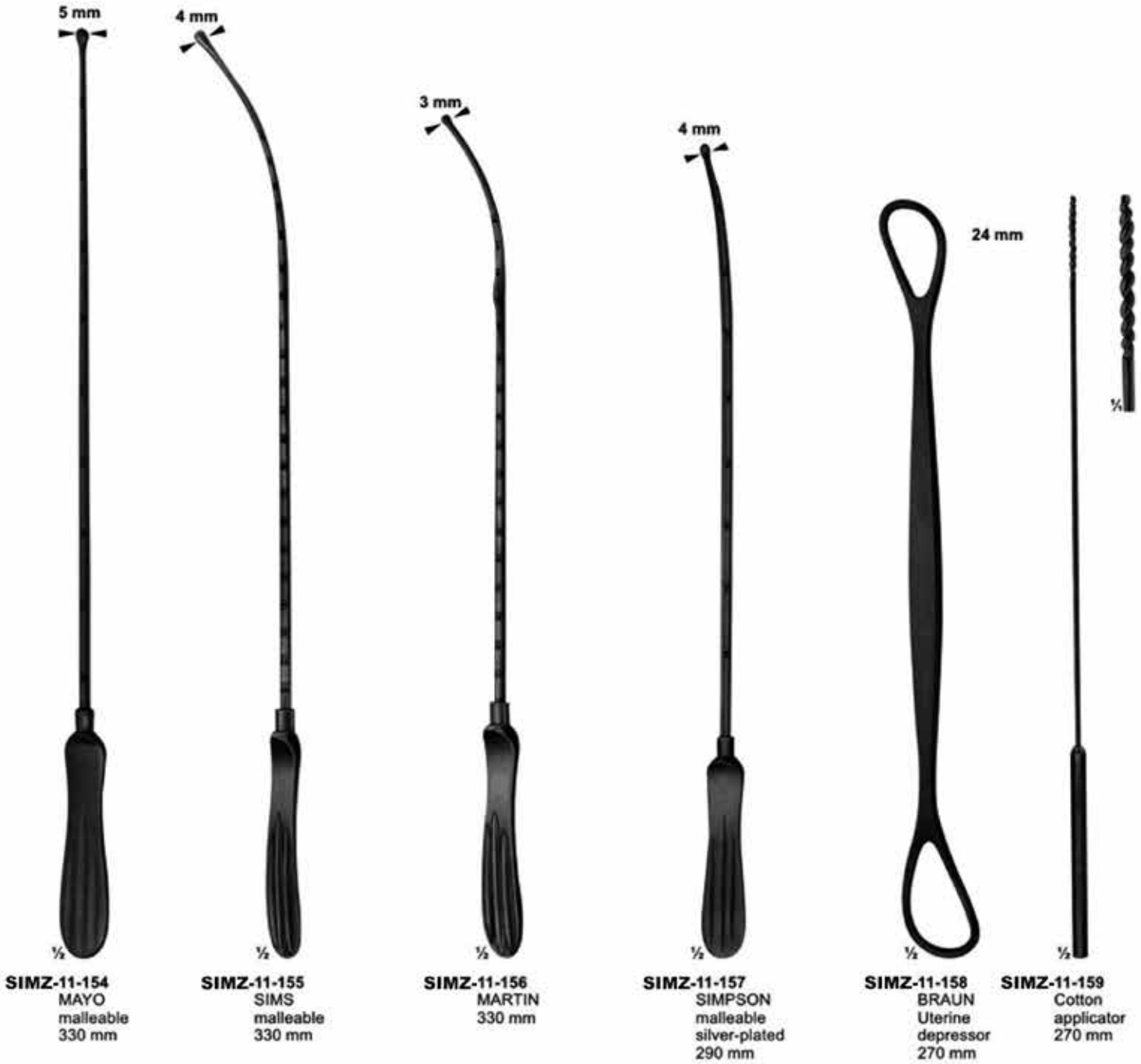



**SIMZ-11-160**  
PELKMANN  
260 mm



**SIMZ-11-161**  
PELKMANN  
260 mm



**SIMZ-11-162**  
BOZEMANN  
250 mm



**SIMZ-11-163**  
BOZEMANN  
255 mm

Jaws with longitudinal groove

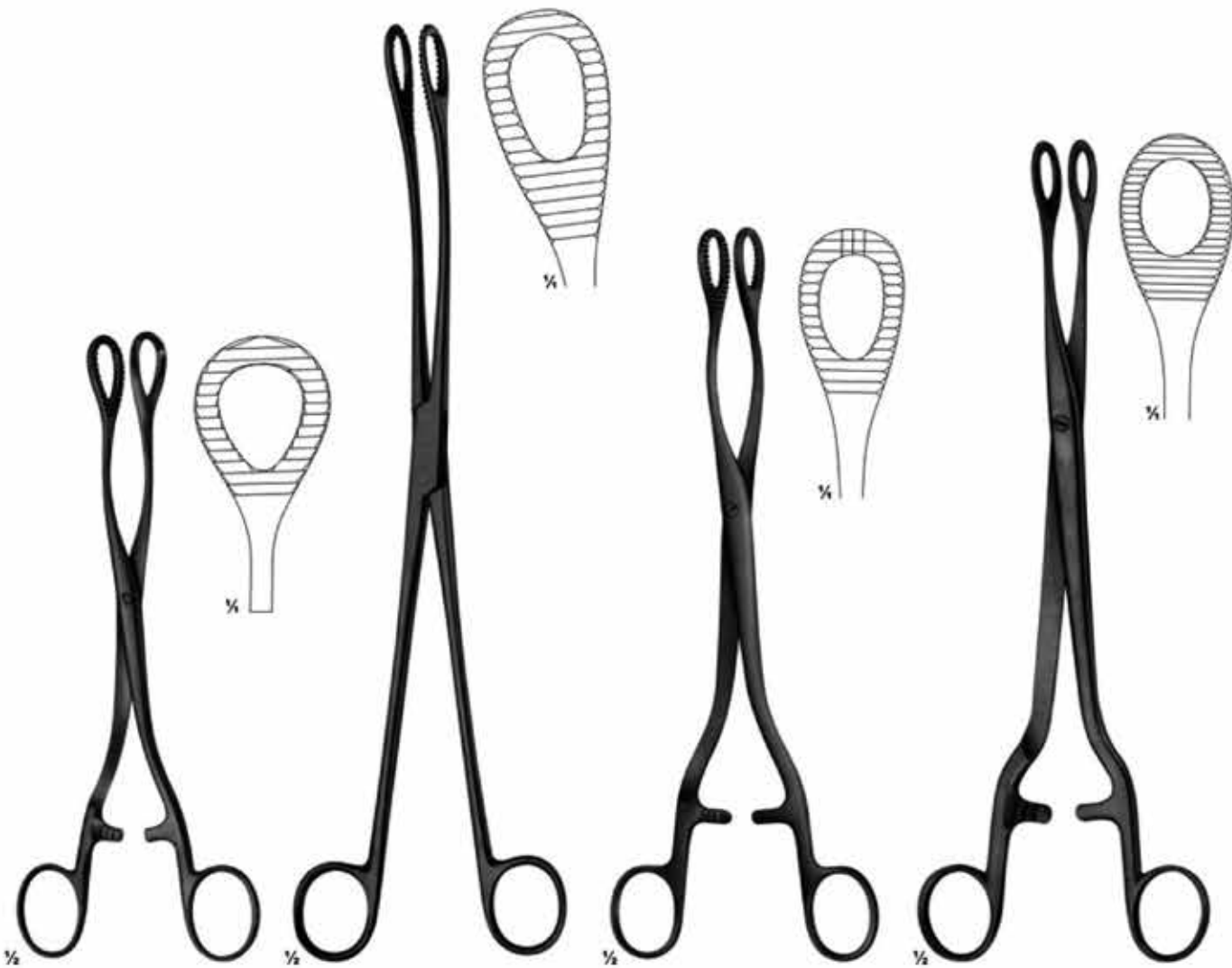

**SIMZ-11-164**  
HEYWOOD-SMITH  
200 mm

**SIMZ-11-165**  
KELLY  
320 mm

**SIMZ-11-166**  
HEYWOOD-SMITH  
250 mm

**SIMZ-11-167**  
NOTO  
280 mm



**SIMZ-12-101**  
Langenbeck  
13 cm / 5 1/8"

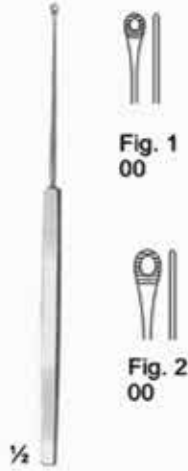

**SIMZ-12-102**  
Shapleigh  
15 cm / 5 1/8"

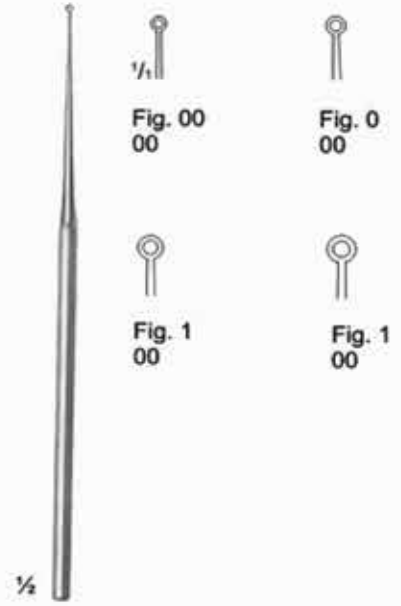

**SIMZ-12-103**  
Buck  
17cm / 6 6/8"



**SIMZ-12-104**  
Buck  
15 cm / 6 6/8"

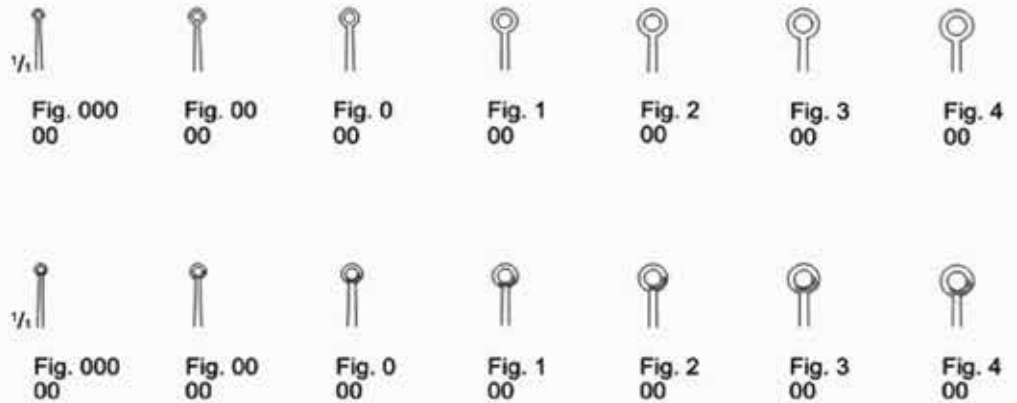



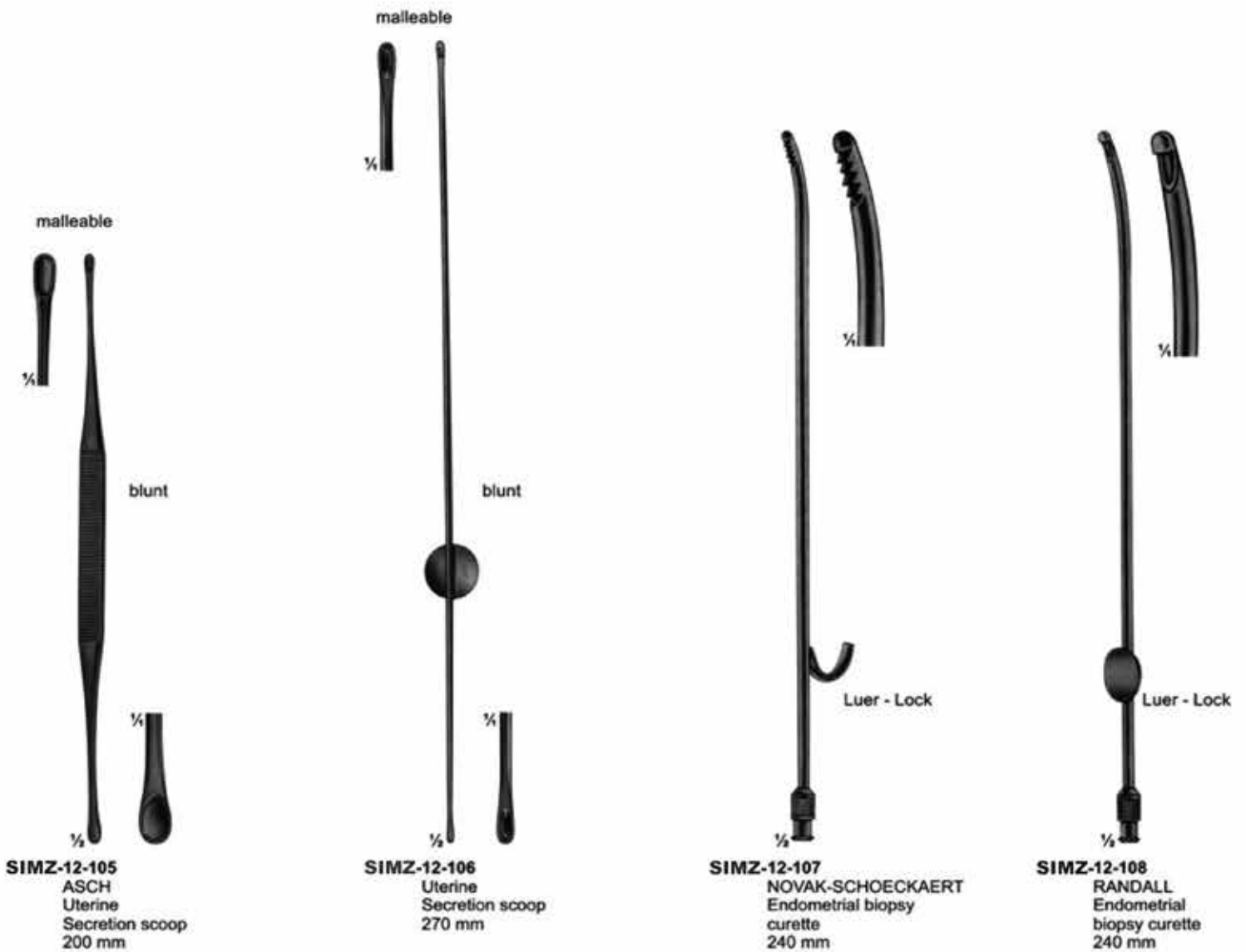



**SIMZ-12-109**  
Hartmann-Wullstein  
shaft length  
85 mm



**SIMZ-12-110**  
Hartmann-Wullstein  
shaft length  
85 mm



**SIMZ-12-111**  
Hartmann  
shaft length  
85 mm



**SIMZ-12-112**  
Hartmann  
shaft length  
85 mm

**12-113**  
14 cm / 5 4/8"  
shaft length  
140 mm



**SIMZ-12-109 - 12-119**

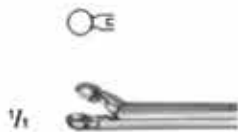

**SIMZ-12-114**  
Hartmann-Herzfeil  
2,0 mm  
shaft length  
85mm



**SIMZ-12-115**  
Hartmann  
3 mm  
shaft length  
85mm



**SIMZ-12-116**  
shaft length  
85mm

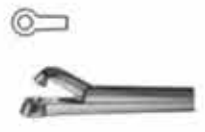

**SIMZ-12-117**  
Hartmann-Hoffmar  
2,0 mm  
85mm

**SIMZ-12-118**  
2,5 mm  
85 mm

**SIMZ-12-119**  
3,0 mm  
85 mm

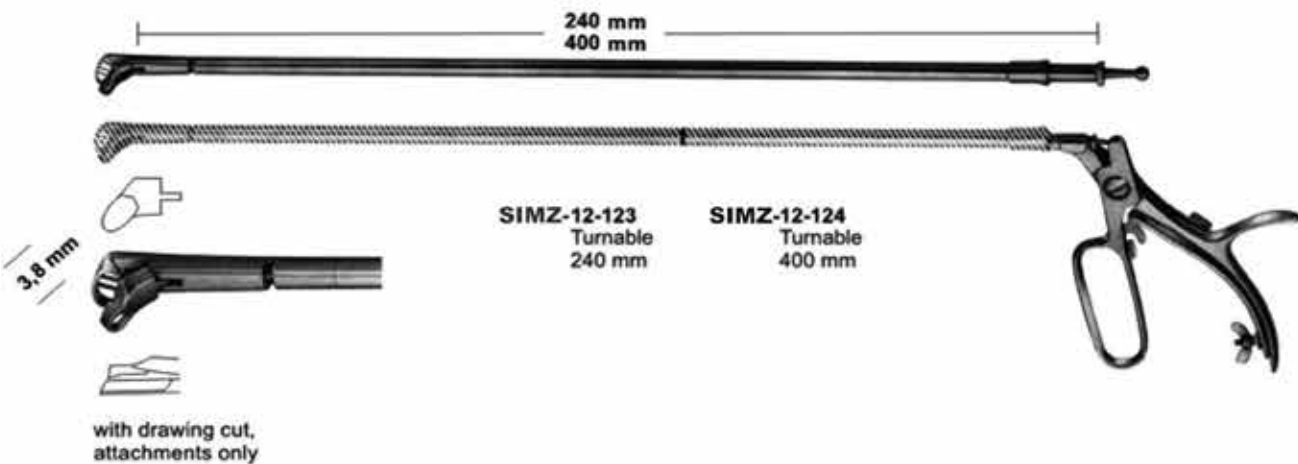
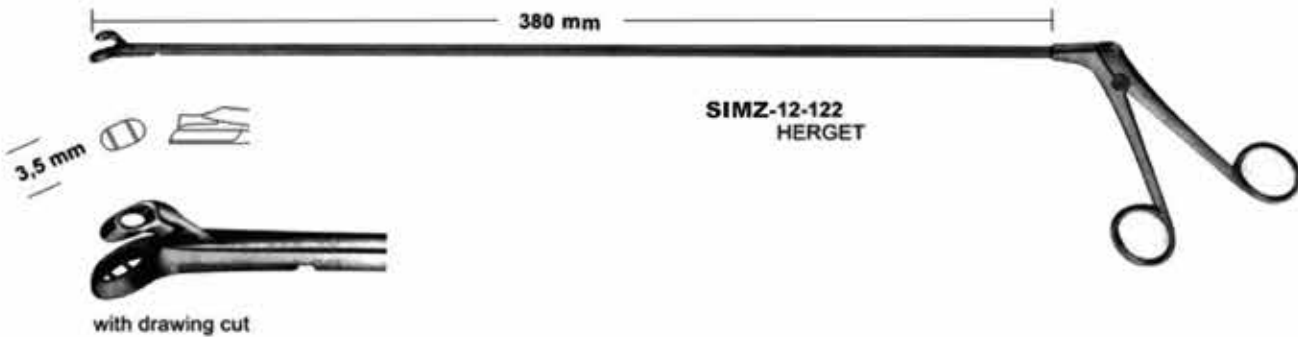
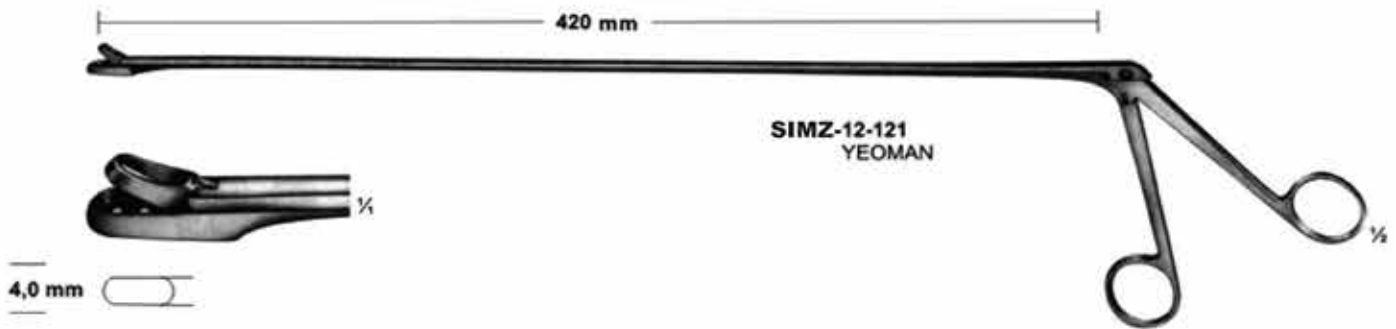
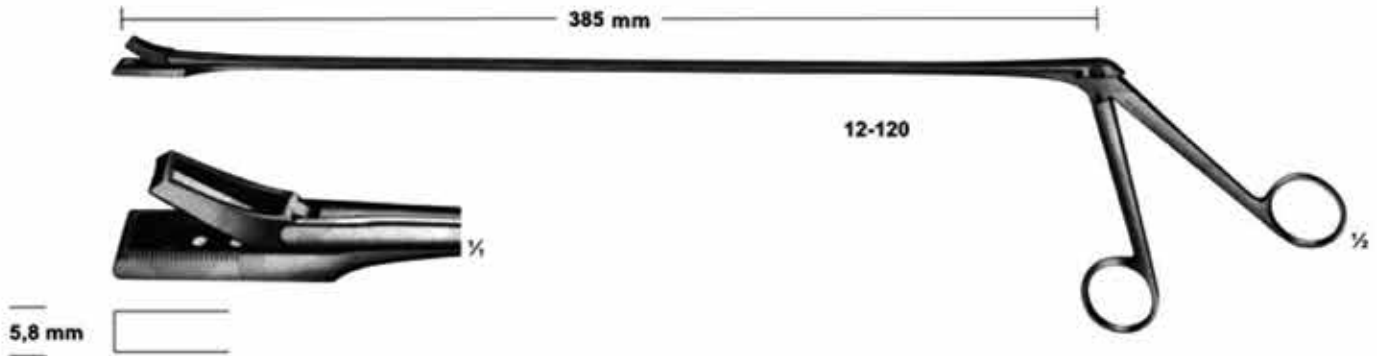

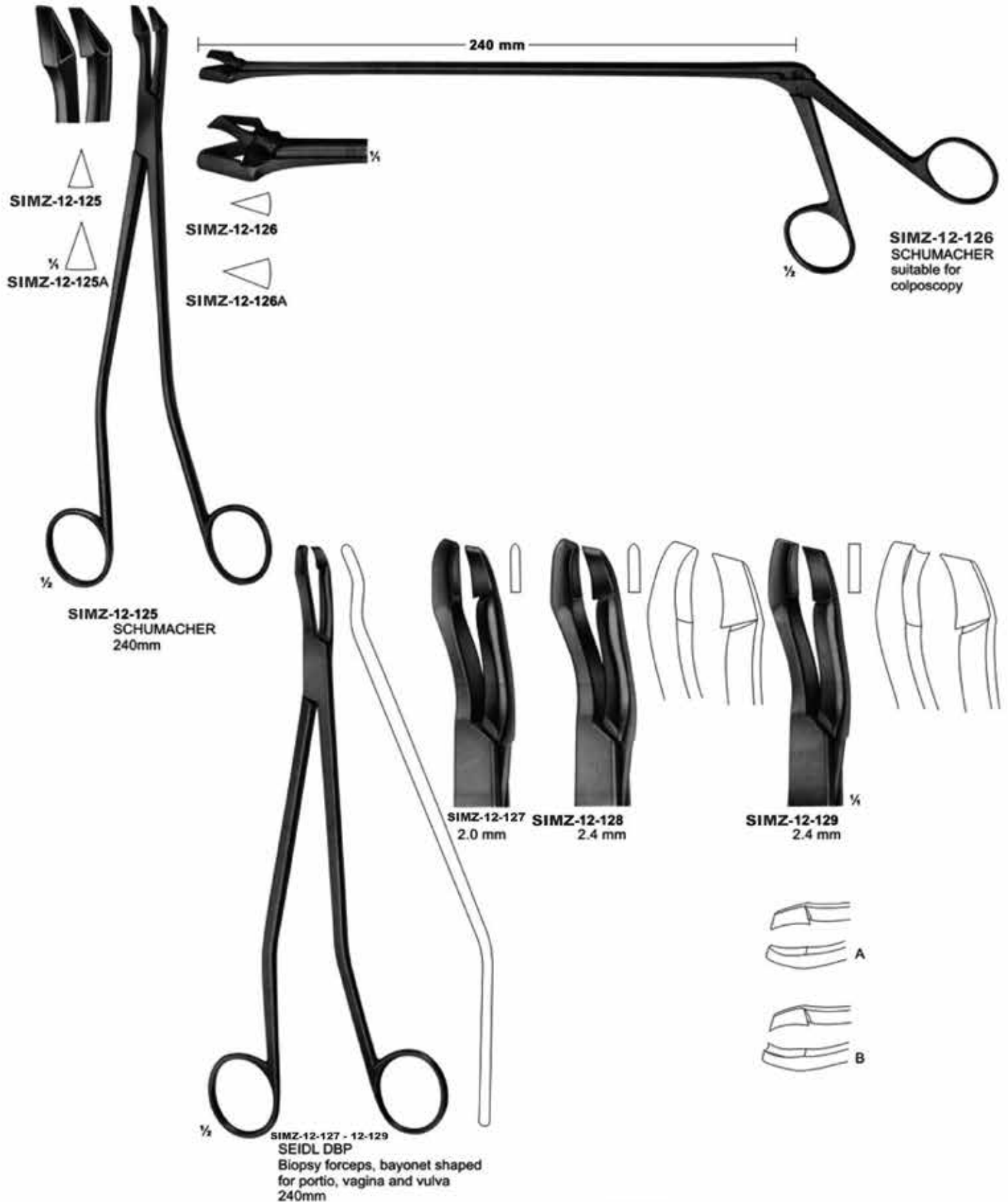

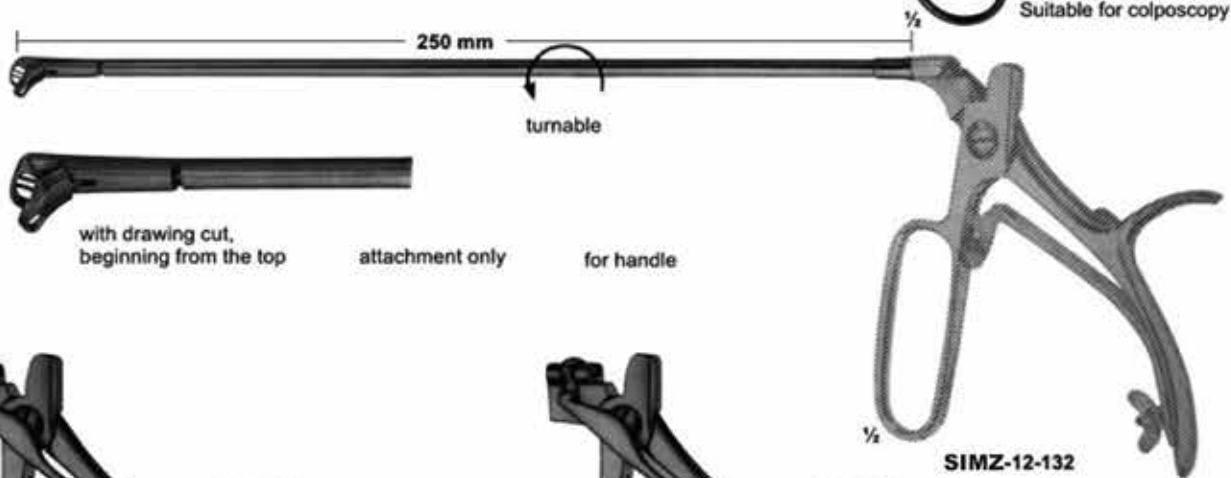
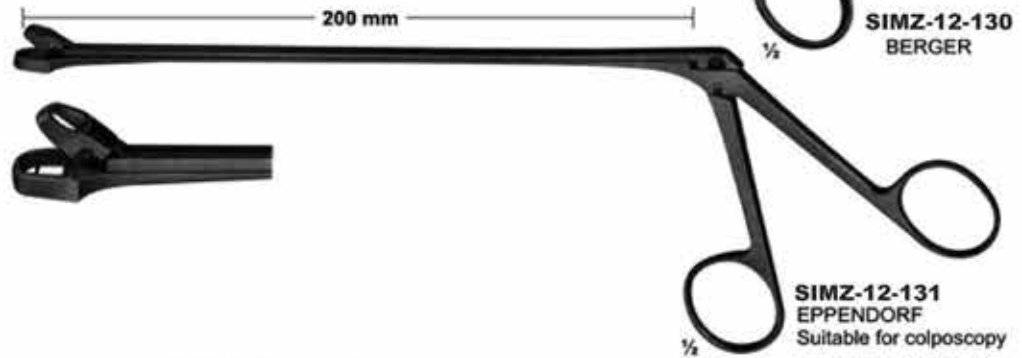
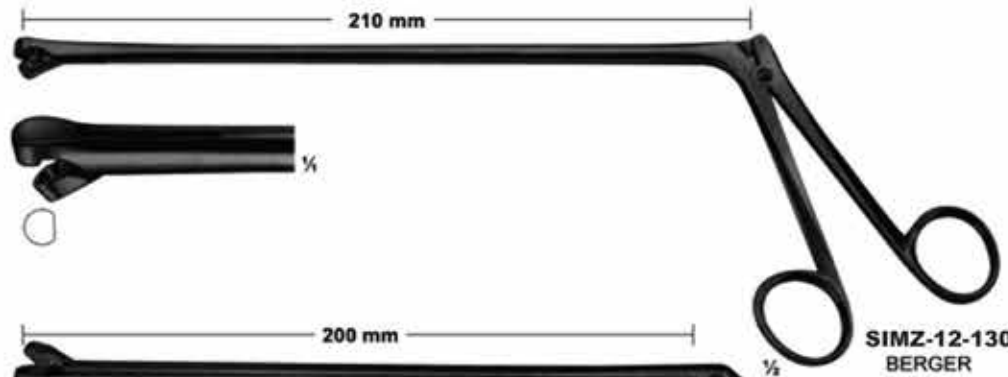

with drawing cut, beginning from the top      attachment only      for handle



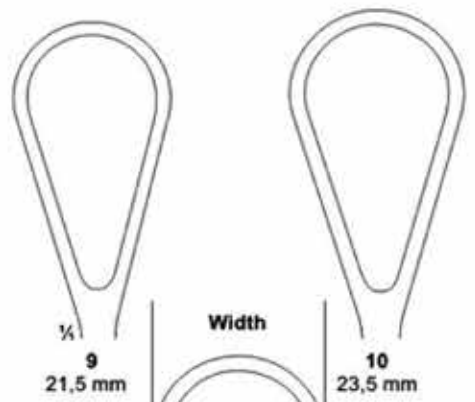
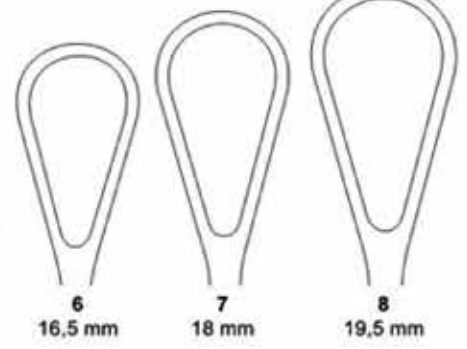
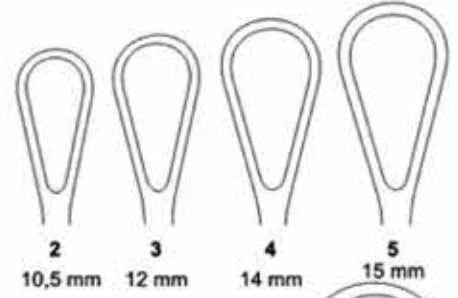
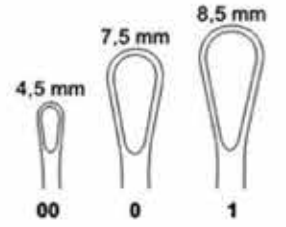

**SIMZ-12-140**  
SIMON  
240 mm



**SIMZ-12-141**  
SCHROEDER  
310 mm



**SIMZ-12-142**  
RECAMIER  
300 mm



**SIMZ-13-101**  
NAEGELE  
355 mm



**SIMZ-13-102**  
NAEGELE  
400 mm



**SIMZ-13-103**  
SIMPSON-BRAUN  
305mm







**SIMZ-13-111**  
BOSE  
165 mm



**SIMZ-13-112**  
BOSE  
165 mm



**SIMZ-13-113**  
sharp



**SIMZ-13-114**  
blunt



**SIMZ-13-115**  
stumpf/blunt

**SIMZ-13-113 - 115**  
180 mm



**SIMZ-13-116**  
FINSEN  
50 mm



**SIMZ-13-117**  
FINSEN  
70 mm



**SIMZ-13-118**  
TROUSSEAU  
120 mm



**SIMZ-13-119**  
LABORDE  
125 mm



**SIMZ-13-120**  
LABORDE  
strong pattern  
135 mm



**SIMZ-13-121**  
Cleaning Brush  
for tracheal tubes  
285 mm

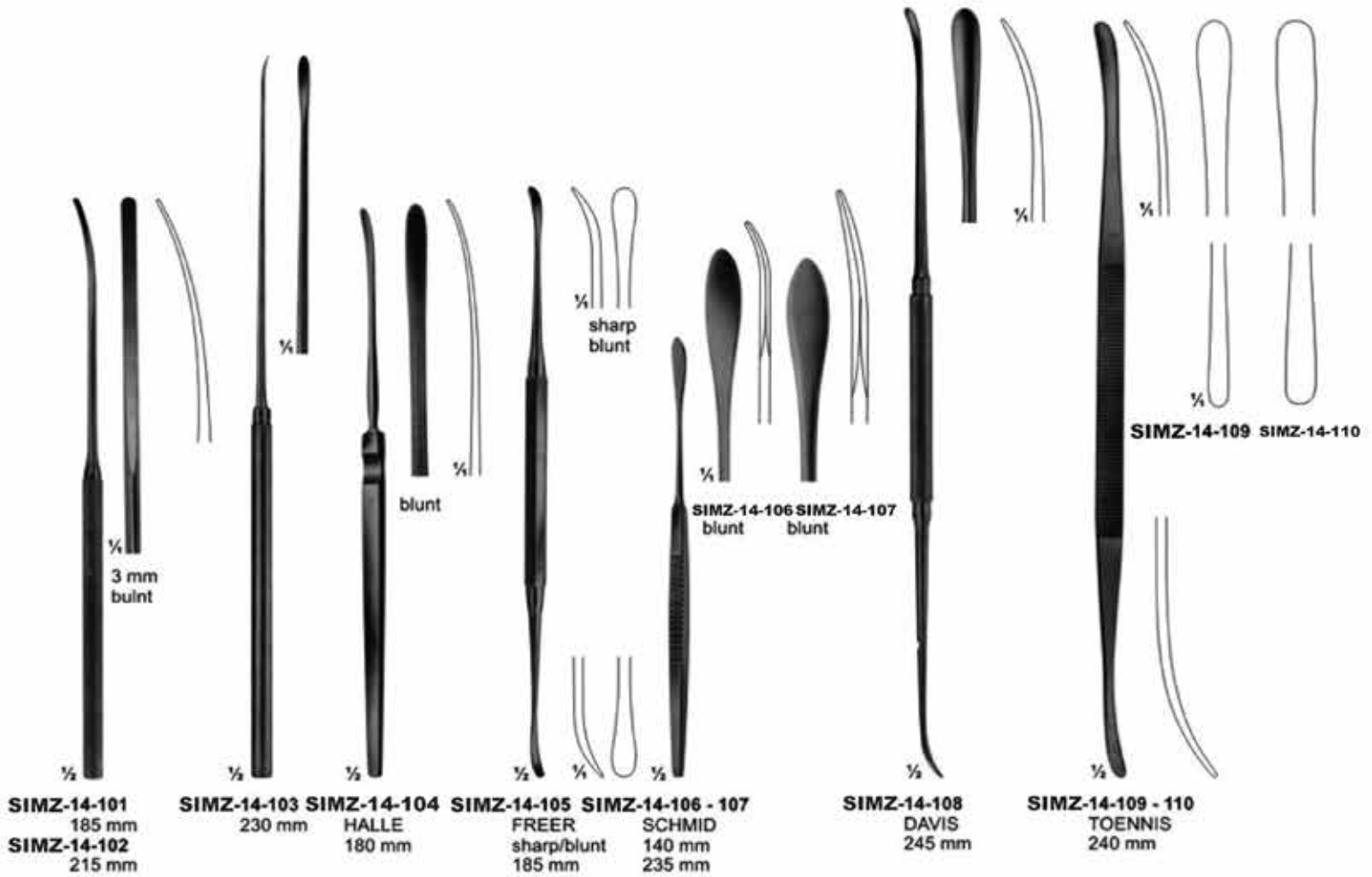

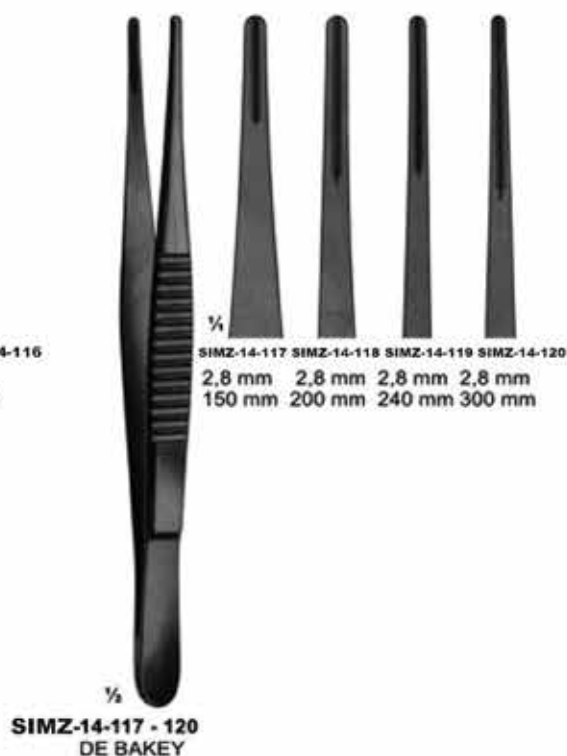
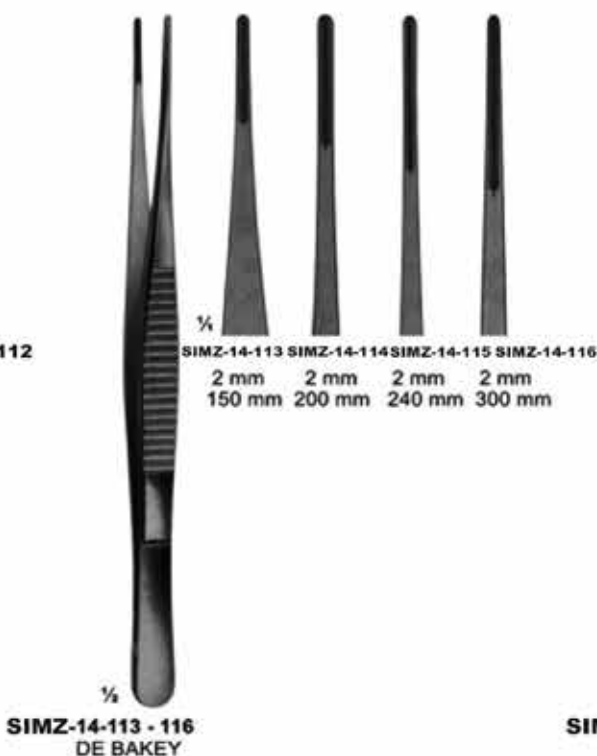
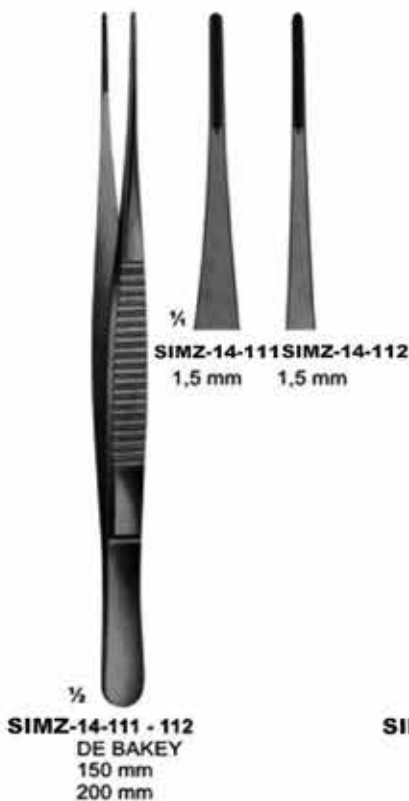

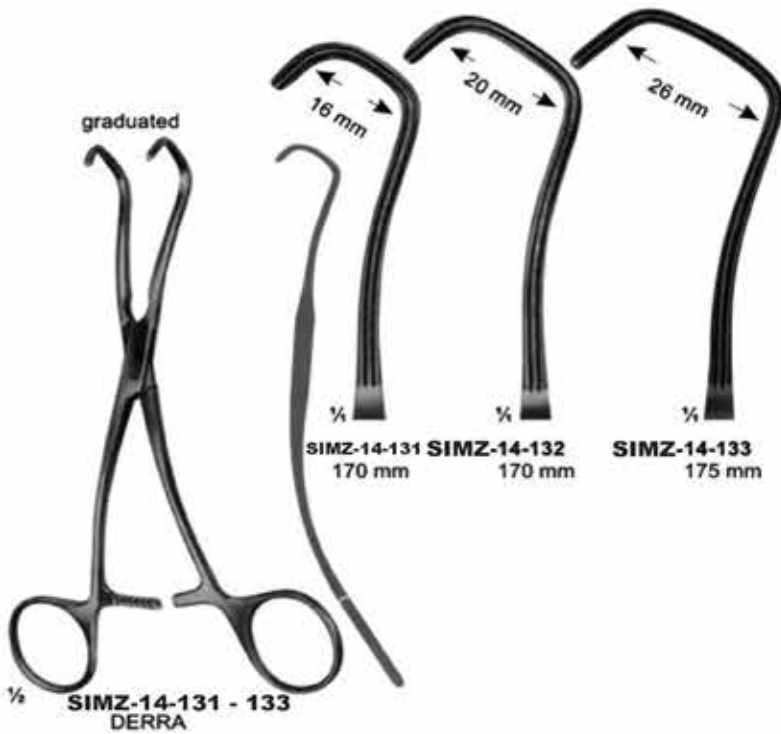
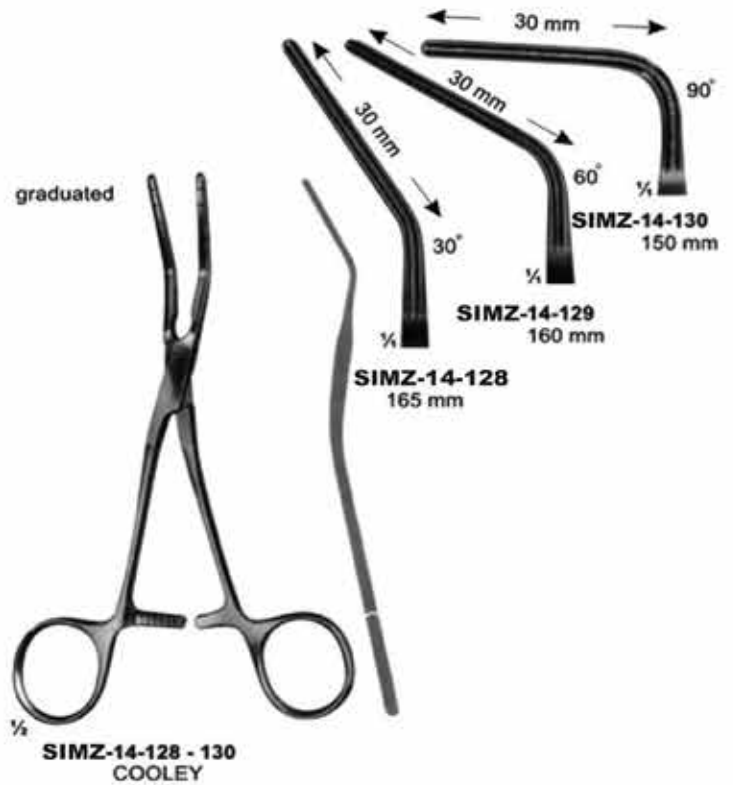
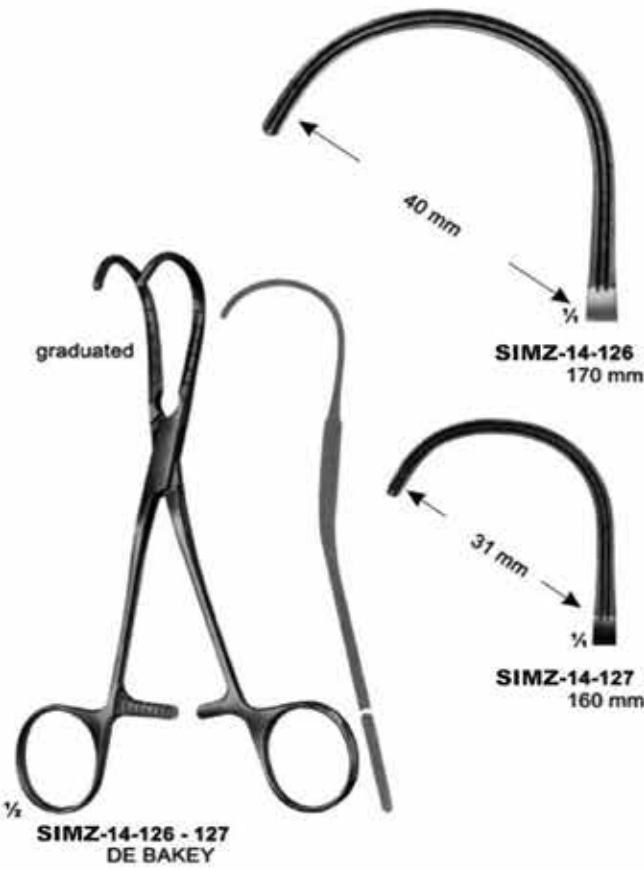





**L**  
**SIMZ-14-144**  
**WEBER**  
**260 mm**



**R**  
**SIMZ-14-145**  
**WEBER**  
**260 mm**

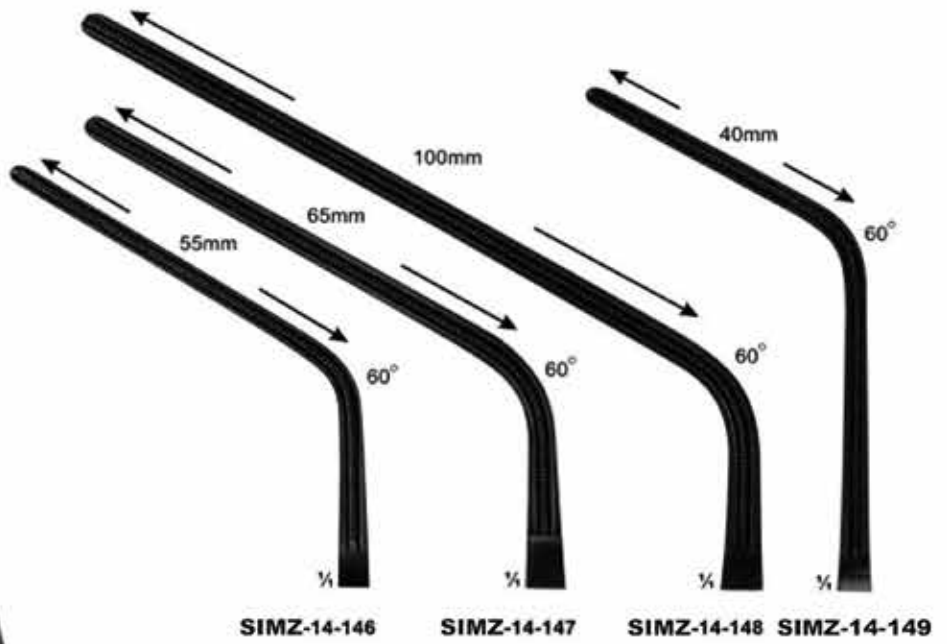

Total Length:	230 mm	280 mm	305 mm	240 mm
Length of jaws:	85 mm	100 mm	135 mm	93 mm

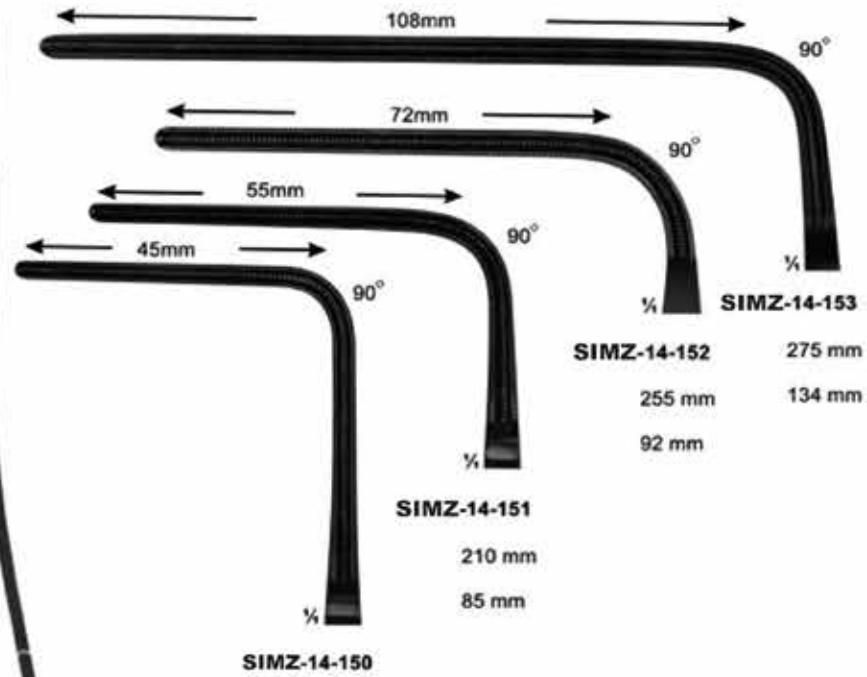

Total Length:	225 mm	210 mm	275 mm	255 mm
Length of jaws:	93 mm	85 mm	134 mm	92 mm



**SIMZ-14-154**  
SCHUMACHER  
Sternum shears  
210 mm



**SIMZ-14-155**  
LEBSCHKE  
Sternum chisel  
200 mm



**SIMZ-14-156**  
230 mm



**SIMZ-14-157**  
COLLIN  
195 mm



**SIMZ-14-158**  
GLUCK  
190 mm



**SIMZ-14-159**  
BETHUNE  
340 mm



**SIMZ-14-160**  
BRUNNER  
Universal pattern  
340 mm



**SIMZ-14-161**  
GIERTZ-STILLE  
250 mm







**SIMZ-14-166**  
**SELLORS**  
Rib spreader-and contractor  
with swivel blades  
200 mm



**SIMZ-14-167**  
**BAILEY**  
150 mm



**SIMZ-14-168 - 169**  
**BAILEY**  
200 mm

**SIMZ-14-168**  
for children

**SIMZ-14-169**  
for adults

**130°** upwards cutting

**SIMZ-15-101**  
1 mm   
KERRISON - JACOBY

FERRIS-SMITH-KERRISON

**SIMZ-15-102**  
2 mm

**SIMZ-15-103**  
3 mm

**SIMZ-15-104**  
4 mm

**SIMZ-15-105**  
5 mm

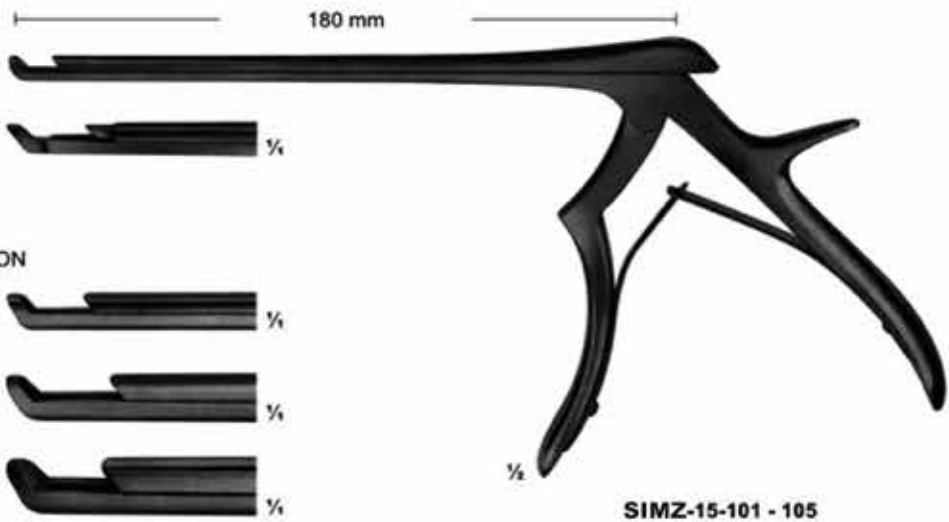

**90°** upwards cutting

KERRISON - JACOBY

**SIMZ-15-106**  
1 mm

**SIMZ-15-107**  
2 mm

FERRIS-SMITH-KERRISON

**SIMZ-15-108**  
3 mm

**SIMZ-15-109**  
4 mm

**SIMZ-15-110**  
5 mm

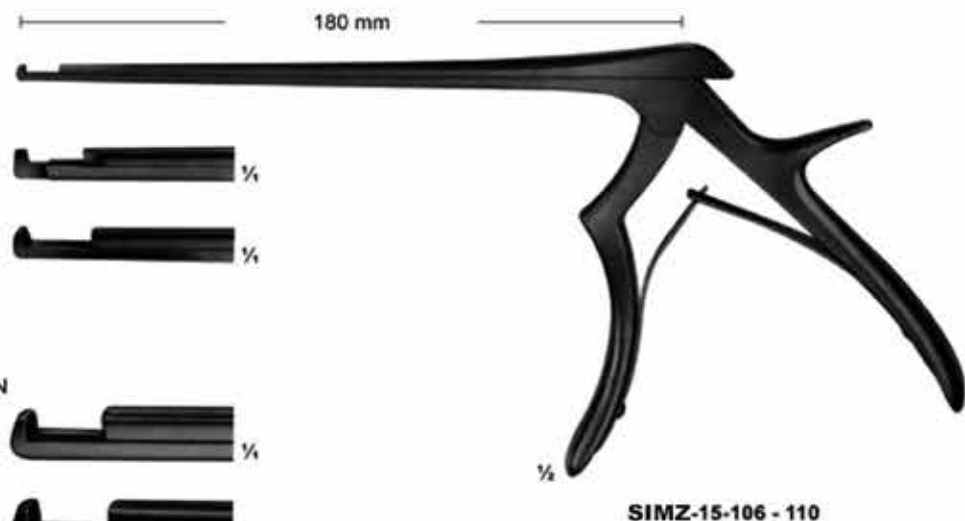

90° upwards cutting

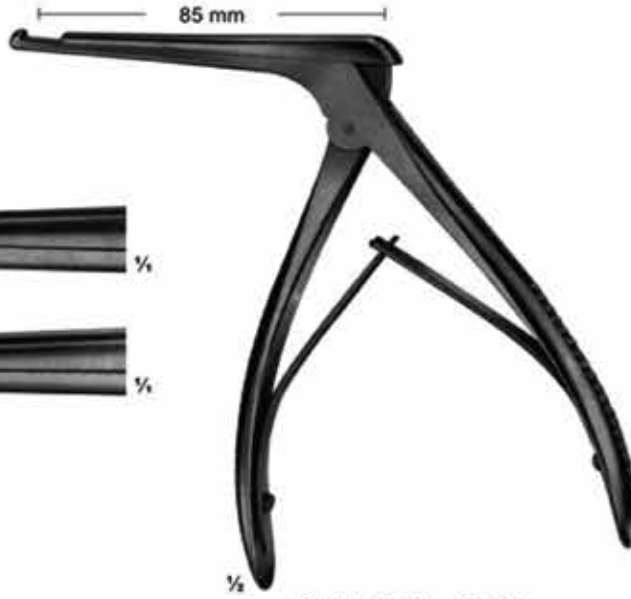

SIMZ-15-111  
4 mm



SIMZ-15-112  
5 mm



SIMZ-15-111 - 15-112  
KERRISON

90° upwards cutting

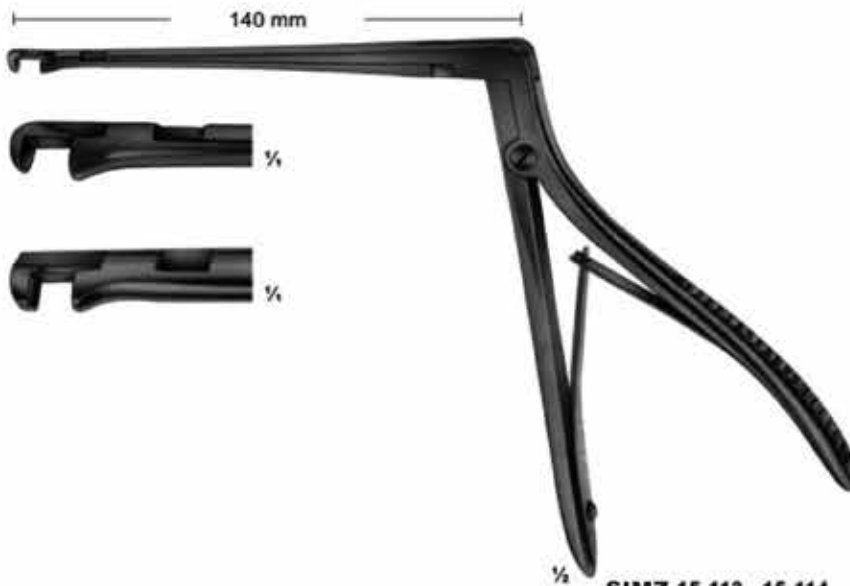

SIMZ-15-113  
3,3 mm



SIMZ-15-114  
4,0 mm



SIMZ-15-113 - 15-114  
HAJEK-KOFLER

LOVE-GRUENWALD

**SIMZ-15-115**  
2 X 10 mm

**SIMZ-15-116**  
3 X 10 mm

SPURLING  
**SIMZ-15-117**  
4 X 10 mm



**SIMZ-15-115 - 15-117**

**SIMZ-15-118**  
2 mm

**SIMZ-15-119**  
3 mm

**SIMZ-15-120**  
4 mm

**SIMZ-15-121**  
5 mm



**SIMZ-15-118 - 15-121**  
CASPAR

150°

**SIMZ-15-122**  
2 mm

**SIMZ-15-123**  
3 mm

**SIMZ-15-124**  
4 mm

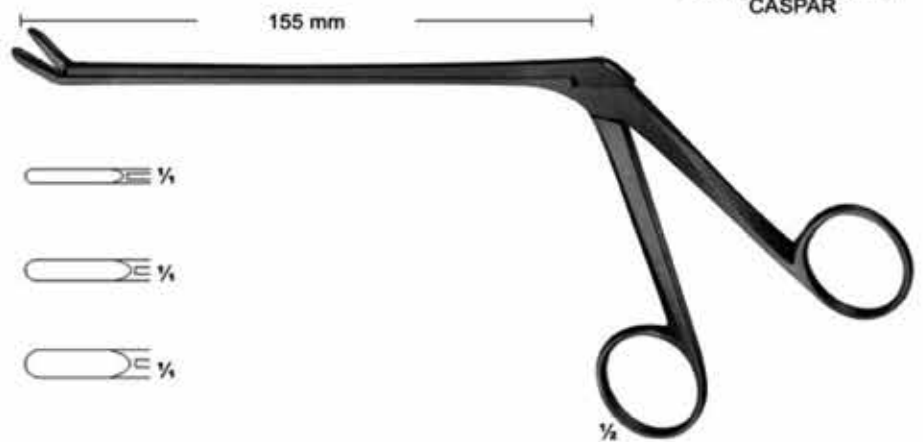

**SIMZ-15-122 - 15-124**  
CASPAR

Angled positions for rongeurs

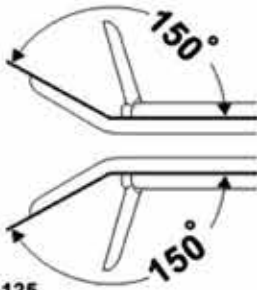

**SIMZ-15-125**  
3,0 mm

**SIMZ-15-126**  
3,6 mm

**SIMZ-15-127**  
4,2 mm

**SIMZ-15-128**  
4,8 mm

**SIMZ-15-129**  
5,8 mm

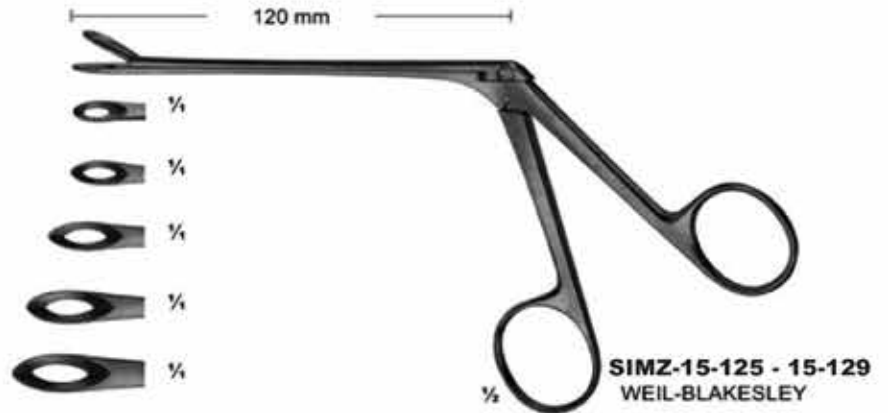
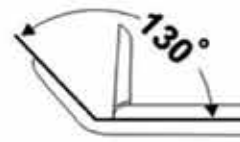

130°

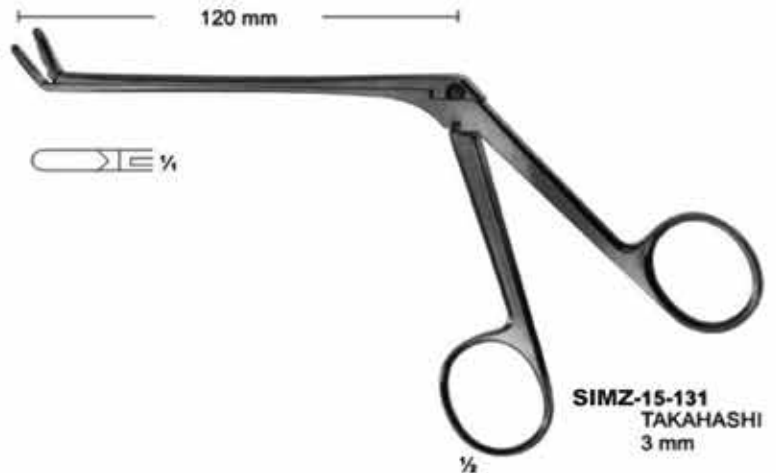

**150°**

Lower part of jaws movable

**SIMZ-15-132**  
2 mm

**SIMZ-15-133**  
3 mm

**SIMZ-15-134**  
4 mm



**SIMZ-15-132 - 15-134**  
CASPAR

Length of shaft 140 mm	Length of shaft 160 mm	Length of shaft 185 mm	size of jaws
---------------------------	---------------------------	---------------------------	--------------

<b>SIMZ-15-135</b>	<b>SIMZ-15-140</b>	<b>SIMZ-15-145</b>	2 X12 mm	¼
<b>SIMZ-15-136</b>	<b>SIMZ-15-141</b>	<b>SIMZ-15-146</b>	3 X12 mm	¼
<b>SIMZ-15-137</b>	<b>SIMZ-15-142</b>	<b>SIMZ-15-147</b>	4 X14 mm	¼
<b>SIMZ-15-138</b>	<b>SIMZ-15-143</b>	<b>SIMZ-15-148</b>	5 X14 mm	¼
<b>SIMZ-15-139</b>	<b>SIMZ-15-144</b>	<b>SIMZ-15-149</b>	6 X16 mm	¼



**SIMZ-15-135 - 15-149**  
CASPAR

**150°**

Length of shaft 140 mm	Length of shaft 160 mm	Length of shaft 185 mm	size of jaws
---------------------------	---------------------------	---------------------------	--------------

<b>SIMZ-15-150</b>	<b>SIMZ-15-153</b>	<b>SIMZ-15-156</b>	3 X12 mm	¼
<b>SIMZ-15-151</b>	<b>SIMZ-15-154</b>	<b>SIMZ-15-157</b>	4 X14 mm	¼
<b>SIMZ-15-152</b>	<b>SIMZ-15-155</b>	<b>SIMZ-15-158</b>	5 X14 mm	¼

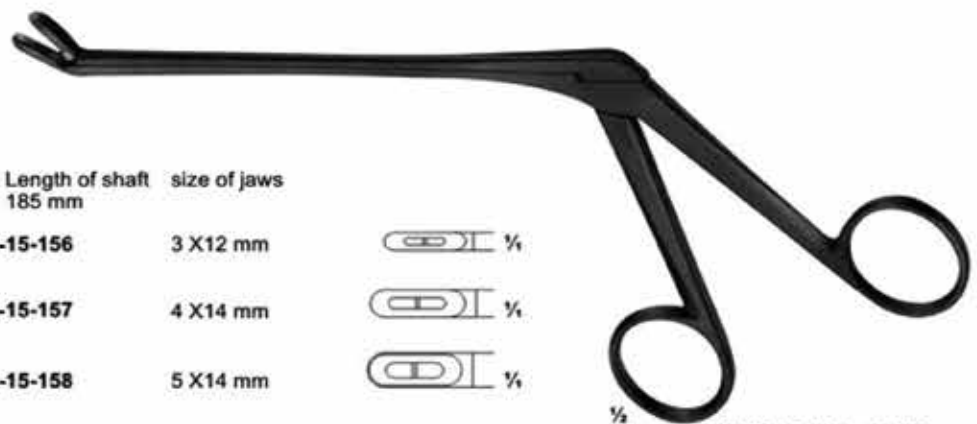

**SIMZ-15-150 - 15-158**  
CASPAR

**SIMZ-15-159**  
4 mm



Osteophyte Rongeur

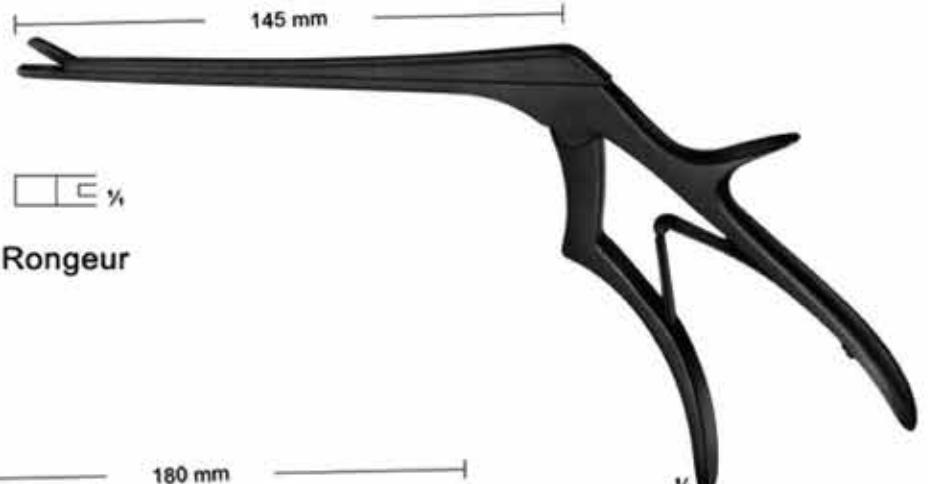

1/2 **SIMZ-15-159**  
CASPAR

**SIMZ-15-160**  
4 mm



Osteophyte Rongeur

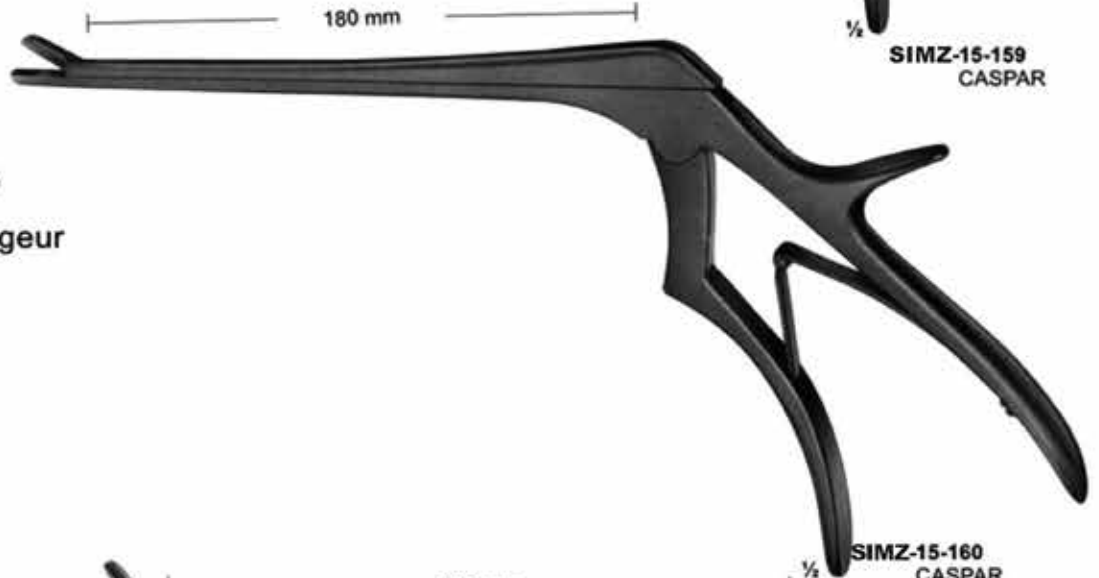

1/2 **SIMZ-15-160**  
CASPAR

**SIMZ-15-161**  
5,5 mm



Very Heavy Pattern

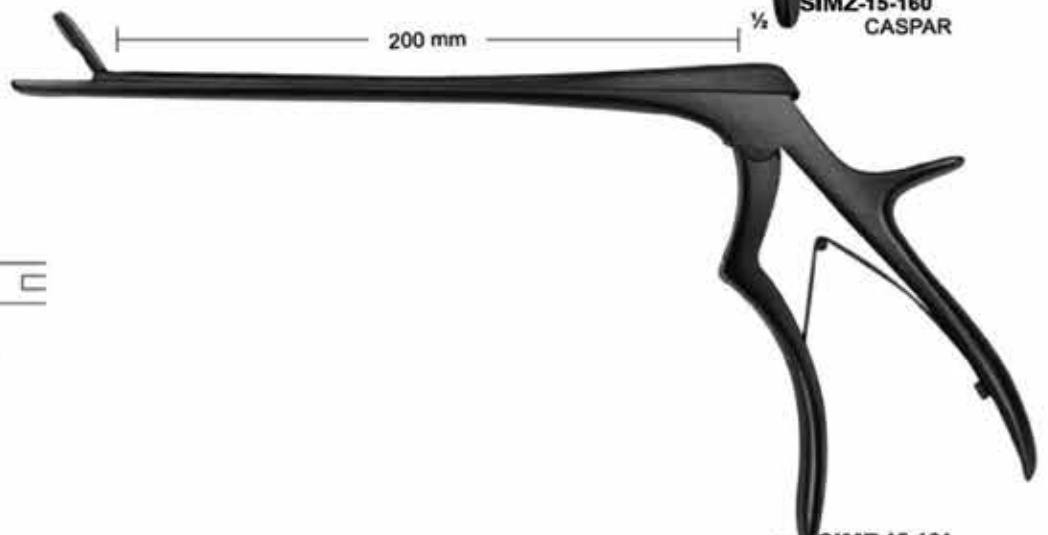

1/2 **SIMZ-15-161**  
WAGNER



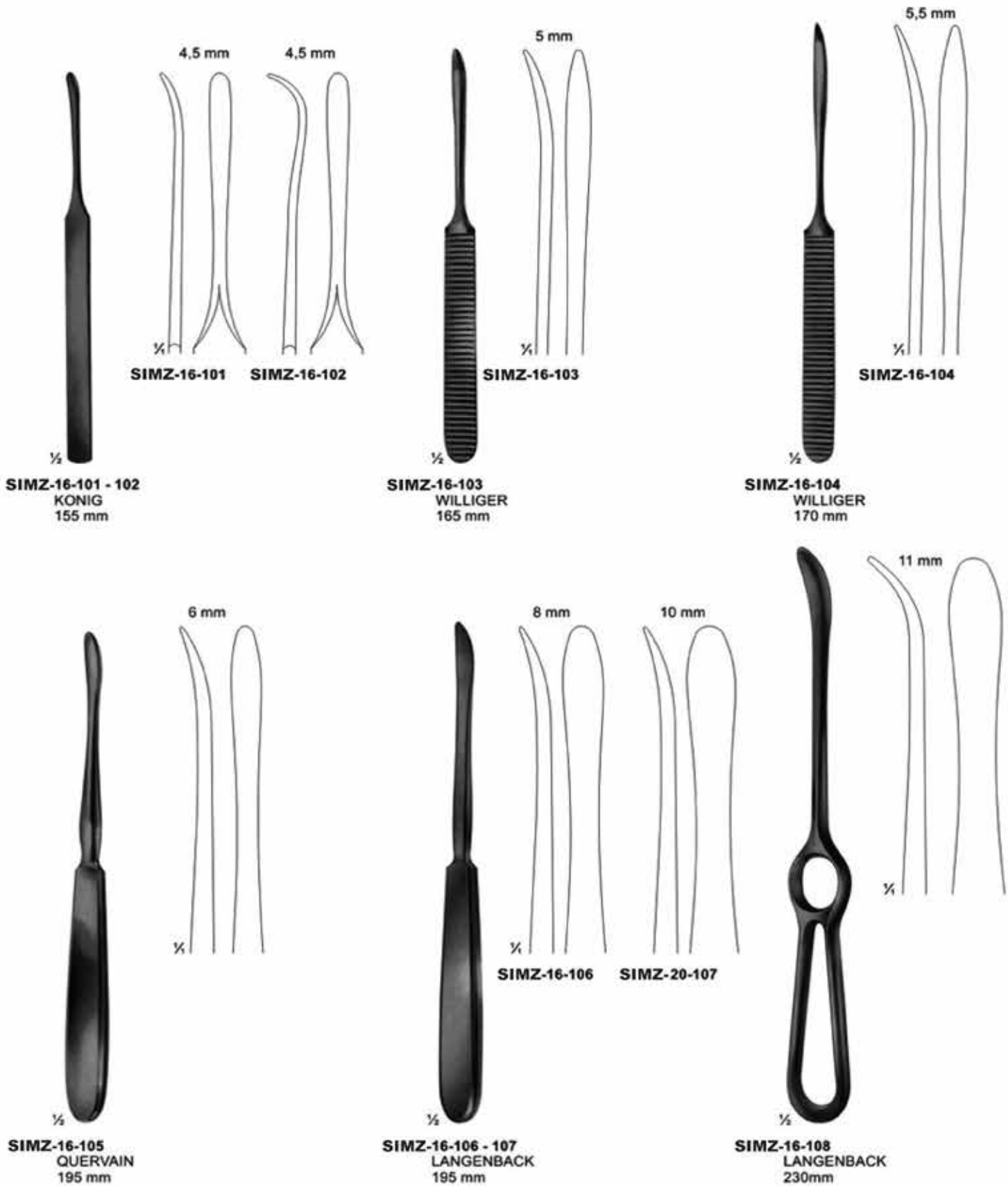

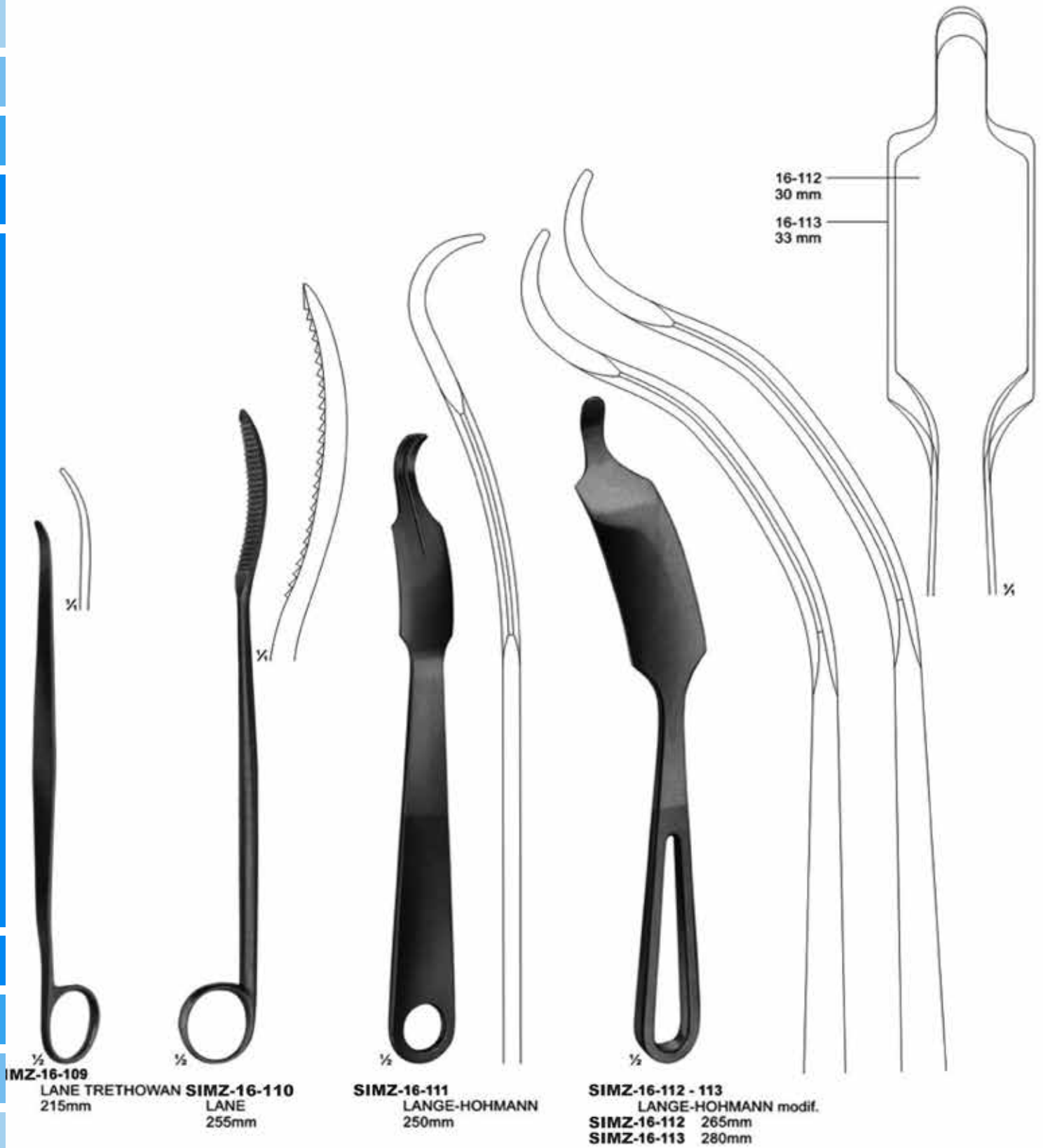

3,2 mm 4,6 mm



SIMZ-16-114 SIMZ-16-115



**SIMZ-16-114**  
PARTSCH  
150 mm

4 mm



**SIMZ-16-116**  
PARTSCH mod. LANGE  
145 mm

4,4 mm

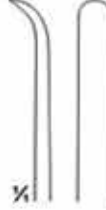

**SIMZ-16-117**  
MC KENTY  
155 mm

5 mm



**SIMZ-16-118**  
KOENIG  
155 mm

8 mm



**SIMZ-16-119**  
TRELAT  
150 mm

4,2 mm



**SIMZ-16-120**  
WILLIGER  
140 mm

6 mm



**SIMZ-16-121**  
WILLIGER  
160 mm

4 mm

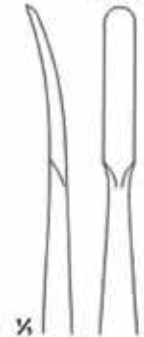

**SIMZ-16-122**  
JOSEPH  
170 mm



**SIMZ-16-123** 7,5 mm  
**SIMZ-16-124** 9 mm

**SIMZ-16-123**  
JOSEPH  
fine, chequered

**SIMZ-16-124**  
coarse, chequered  
165 mm



**SIMZ-16-125**  
8 mm  
fine teeth

**SIMZ-16-126**  
8 mm  
coarse teeth  
175 mm

**SIMZ-16-125 - 16-126**  
LEWIS



9 mm

**SIMZ-16-127**  
MALTZ  
down stroke  
180 mm



**SIMZ-16-128**  
9 mm

**SIMZ-16-129**  
9 mm

**SIMZ-16-128 - 16-129**  
AUFRICHT  
up stroke  
**SIMZ-16-129**  
down stroke  
220 mm



6,5 mm

**SIMZ-16-130**  
GALLAHER  
190 mm



**SIMZ-16-131**  
JACOBSON  
140 mm



**SIMZ-16-132**  
MARTINI  
140 mm



**SIMZ-16-133**  
MARTINI  
140 mm



**SIMZ-16-134**  
WILLIGER  
145 mm



**SIMZ-16-135**  
JANSEN  
160 mm



**SIMZ-16-136**  
BARTH  
180 mm



**SIMZ-16-137**  
VOLKMANN  
130 mm



**SIMZ-16-138**  
VOLKMANN  
145 mm



**SIMZ-16-139**  
VOLKMANN  
170 mm

**Mallets** Weights refer to the heads of the mallets

**Hammer** Die Gewichtsangaben beziehen sich auf den Kopf des jeweiligen Hammers



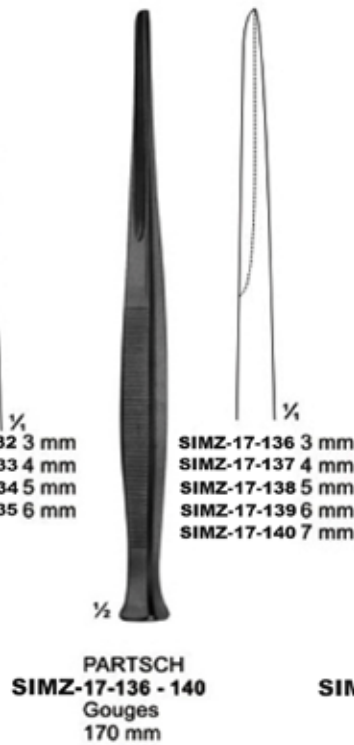
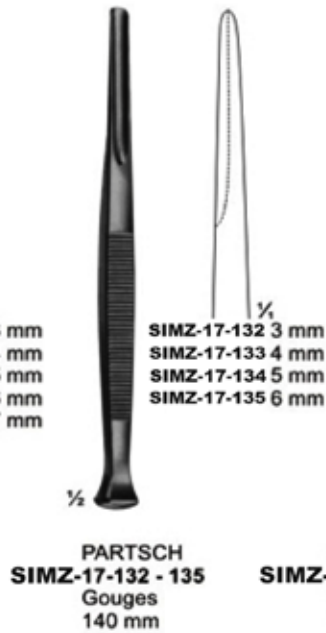
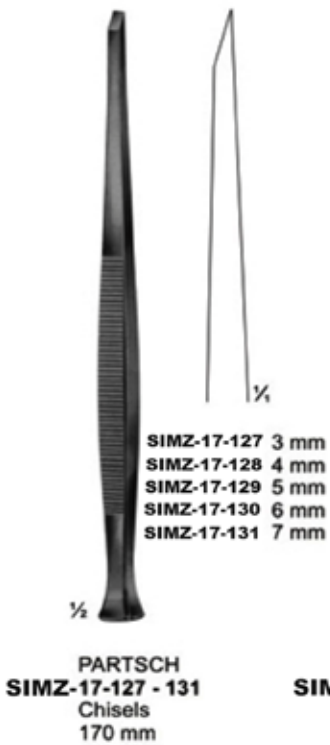
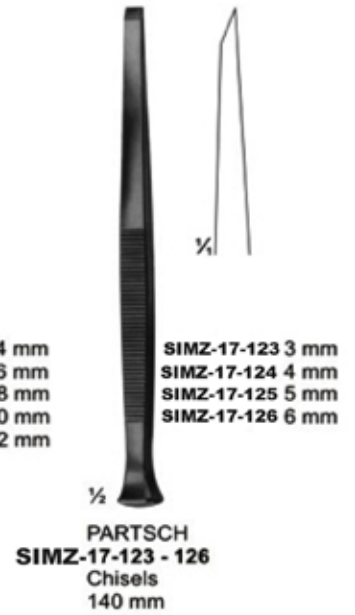
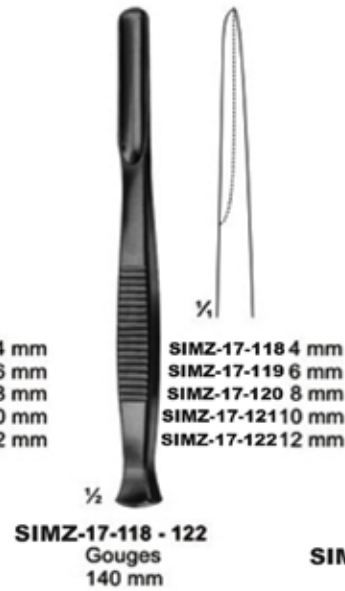



**SIMZ-17-145**  
Patella forceps  
185 mm



**SIMZ-17-146**  
Forceps with  
ratchet fixation  
140 mm



**SIMZ-17-147**  
Forceps with  
thread fixation  
170 mm



**SIMZ-17-148**  
Forceps with  
thread fixation  
235 mm

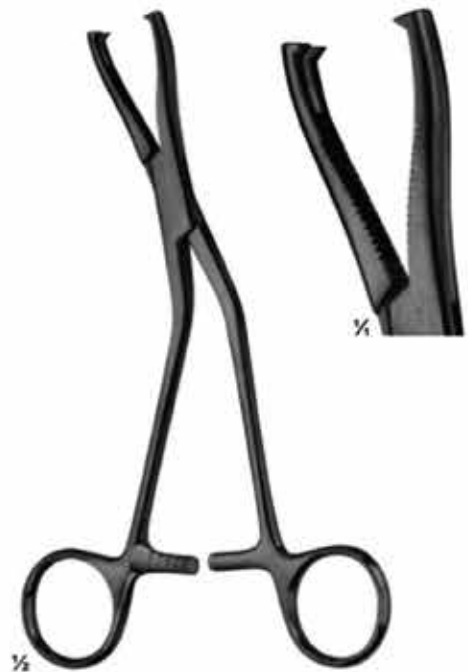

**SIMZ-17-149**  
DINGMANN  
185 mm





**SIMZ-17-154** 170 mm  
**SIMZ-17-155** 205 mm



210 mm



175 mm



**SIMZ-17-158**  
LUER  
150 mm



**SIMZ-17-159**  
LUER  
155 mm



**SIMZ-17-160**  
BLUMENTHAL  
155 mm



**SIMZ-17-161**  
BLUMENTHAL  
150 mm



**SIMZ-17-162 - 163**  
JANSEN  
175 mm



**SIMZ-17-164**  
BANE-HARTMANN  
175 mm



**SIMZ-17-165**  
STILLE  
235 mm



**SIMZ-17-166**  
LEKSELL-STILLE  
240mm



**SIMZ-17-167**  
STILLE-RUSKIN  
240mm



**SIMZ-17-168**  
LISTON  
curved on flat  
240 mm



**SIMZ-17-169**  
LISTON  
straight  
280 mm

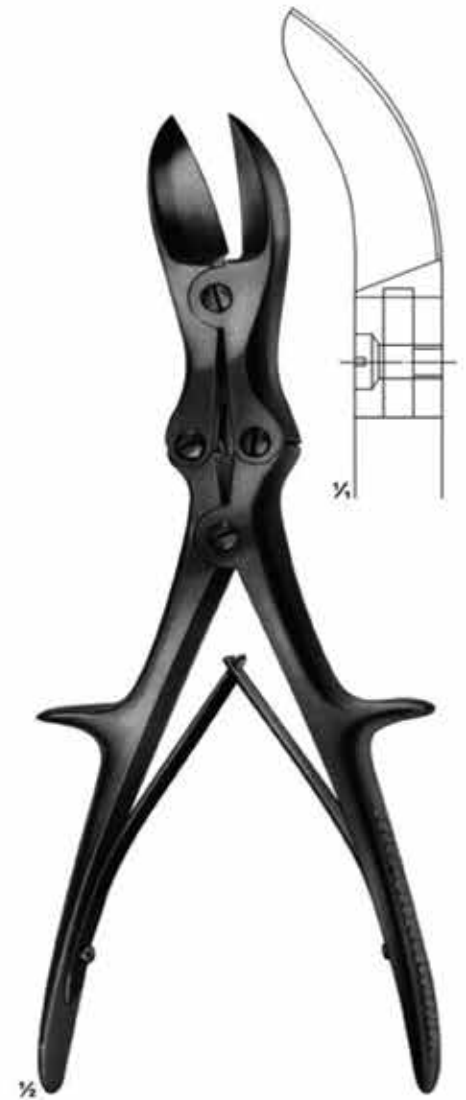

**SIMZ-17-170**  
LISTON  
curved on flat  
280 mm

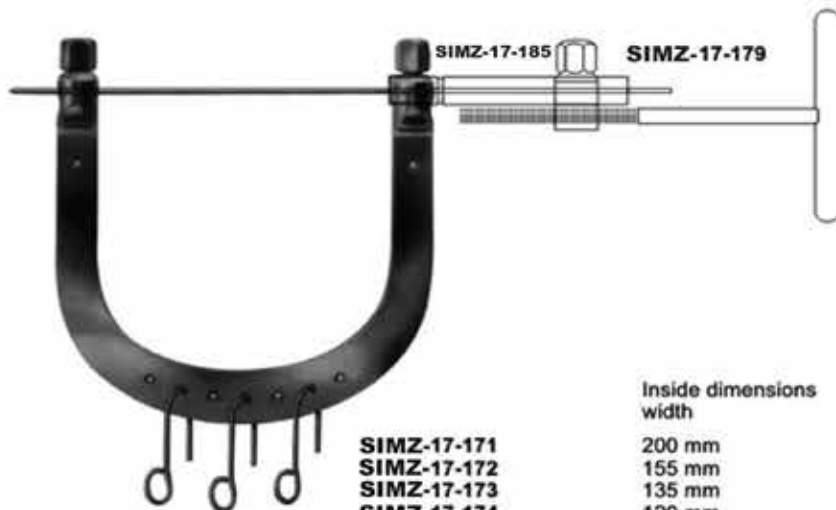

**SIMZ-17-171 - 17-177**  
**KIRSCHNER**  
 Wire traction bows,  
 to be used with  
 KIRSCHNER-wires  
 up to 2.5 mm diam.,  
 With 3 hooks,  
 stainless steel

**SIMZ-17-171**  
**SIMZ-17-172**  
**SIMZ-17-173**  
**SIMZ-17-174**  
**SIMZ-17-175**  
**SIMZ-17-176**  
**SIMZ-17-177**

Inside dimensions width	depth	
200 mm	155 mm	for the hip
155 mm	155 mm	for the femur
135 mm	130 mm	for the knee
120 mm	120 mm	for the knee
105 mm	100 mm	for the knee
95 mm	110 mm	for the calcaneus
95 mm	70 mm	for the arm and elbow



**SIMZ-17-178**  
 Wrench, double - ended,  
 for wire traction bows



**SIMZ-17-179**  
 Wire tightener, with  
 clamping jaws



**SIMZ-17-182 - 17-184**  
**KIRSCHNER**  
 Wire traction bows, modified,  
 adjustable in width, holds wire  
 securely, with 1 hook

<b>SIMZ-17-182</b>	max. 105 mm
<b>SIMZ-17-183</b>	max. 160 mm
<b>SIMZ-17-184</b>	max. 200 mm
<b>SIMZ-17-182</b>	80-95 mm
<b>SIMZ-17-183</b>	90-120 mm
<b>SIMZ-17-184</b>	140-170 mm
diam upto	
<b>SIMZ-17-182</b>	1,6 mm
<b>SIMZ-17-183</b>	2,0 mm
<b>SIMZ-17-184</b>	2,5 mm



**SIMZ-17-180**  
 Traction hook only,  
 large size



**SIMZ-17-181**  
 Traction hook only,  
 small size



**SIMZ-17-185**  
 Fixation clamp, to secure clamping  
 jaws of 17-179 stainless steel

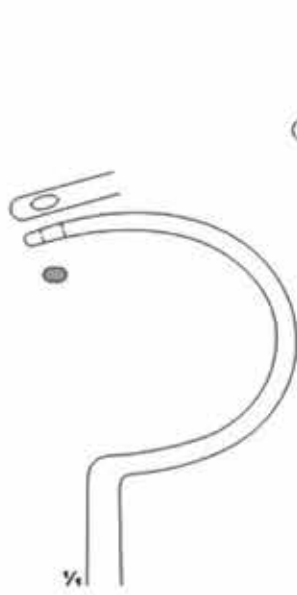

**SIMZ-17-186**  
275 mm

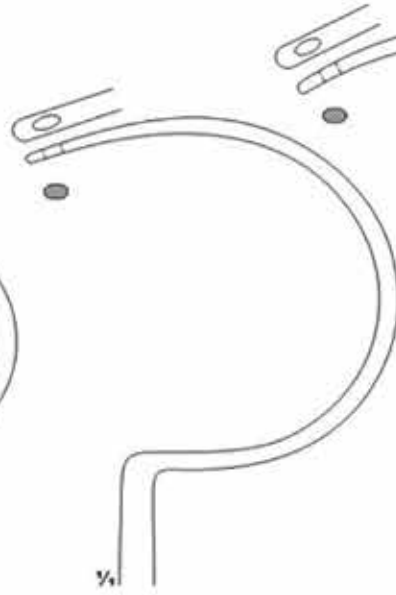

**SIMZ-17-187**  
285 mm

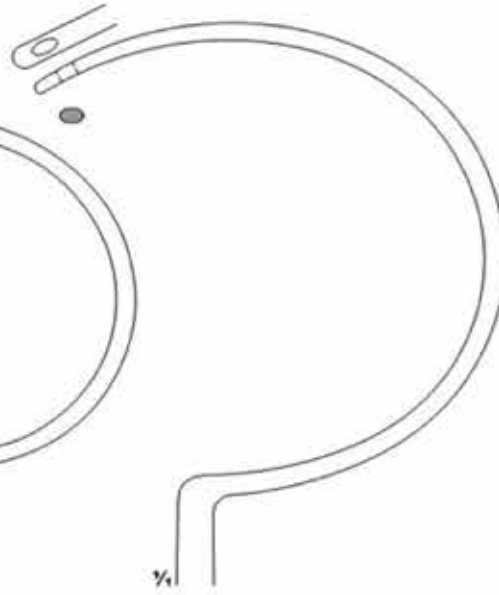

**SIMZ-17-188**  
305 mm



**SIMZ-17-186 - 17-188**  
DEMEL  
Wire guides

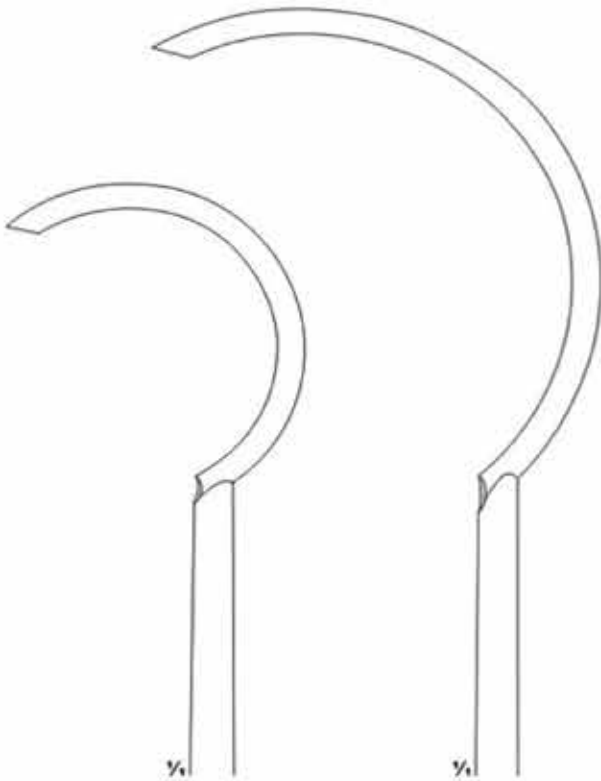

**SIMZ-17-189**  
240 mm



**SIMZ-17-190**  
270 mm



**SIMZ-17-191**  
225 mm



**SIMZ-17-192**  
DUROGRIP  
Holding forceps for cerclage  
wire, with lateral jaws to avoid  
wire slipping off  
170 mm



**SIMZ-17-193**  
DUROGRIP  
Wire, tightening pliers,  
Ligature pliers  
150 mm



**SIMZ-17-194**  
DUROGRIP  
Wire, tightening pliers,  
Ligature pliers  
150 mm



**SIMZ-17-195**  
with serrated jaws  
140 mm



**SIMZ-17-196**  
one jaw smooth,  
one jaw serrated  
140 mm



**SIMZ-17-197**  
with serrated jaws

**SIMZ-17-198**  
with longitudinal and  
transversal grooves  
170 mm



**SIMZ-17-199**  
190 mm



**SIMZ-17-192**  
DUROGRIP  
Holding forceps for cerclage wire, with lateral jaws to avoid wire slipping off  
170 mm



**SIMZ-17-193**  
DUROGRIP  
Wire, tightening pliers, Ligature pliers  
150 mm



**SIMZ-17-194**  
DUROGRIP  
Wire, tightening pliers, Ligature pliers  
150 mm



**SIMZ-17-195**  
with serrated jaws  
140 mm



**SIMZ-17-196**  
one jaw smooth, one jaw serrated  
140 mm



**SIMZ-17-197**



**SIMZ-17-198**



**SIMZ-17-197**  
with serrated jaws  
**SIMZ-17-198**  
with longitudinal and transversal grooves  
170 mm



**SIMZ-17-199**  
190 mm





**SIMZ-17-200**  
130 mm

**SIMZ-17-201**  
180 mm

**SIMZ-17-200 - 17-201**  
Extraction pliers  
for boring wires



**SIMZ-17-202**  
Flat-nosed pliers,  
parallel  
185 mm



**SIMZ-17-203**  
Vise grip  
200 mm

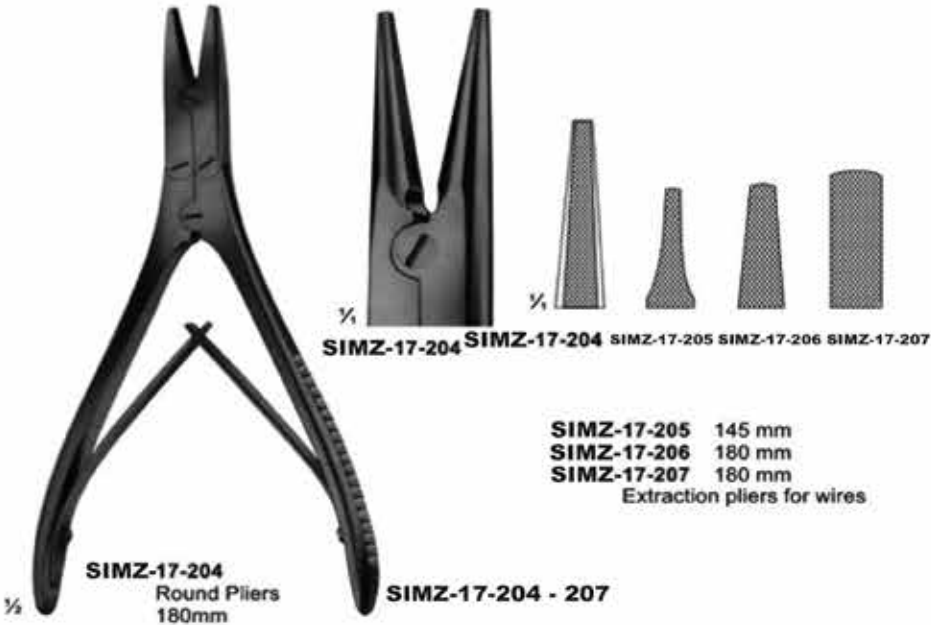

**SIMZ-17-204**  
Round Pliers  
180mm

**SIMZ-17-204** **SIMZ-17-204** **SIMZ-17-205** **SIMZ-17-206** **SIMZ-17-207**

**SIMZ-17-205** 145 mm  
**SIMZ-17-206** 180 mm  
**SIMZ-17-207** 180 mm  
Extraction pliers for wires

**SIMZ-17-204 - 207**



**SIMZ-17-208**  
Bending pliers  
for wires up to  
1.8 mm diam.



**SIMZ-17-209**  
ANGLE  
130 mm

**SIMZ-17-210**  
DUROTIP  
ANGLE  
130 mm

for soft wire up to diam.	0,5 mm	0,6 mm
for hard wire up to diam.	0,3 mm	0,4 mm

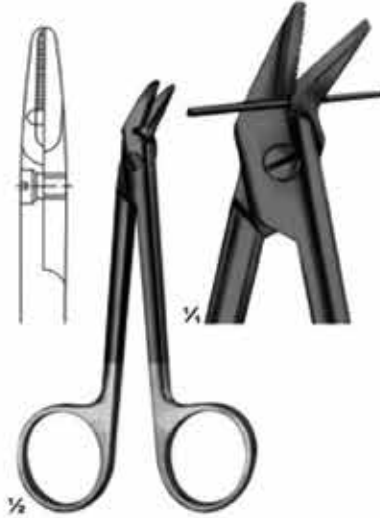

**SIMZ-17-211**  
120 mm

**SIMZ-17-212**  
DUROTIP  
120 mm

for soft wire up to diam.	1,2 mm	1,2 mm
for hard wire up to diam.	0,8 mm	0,8 mm



**SIMZ-17-213**  
HARVEY  
125 mm

0,4 mm
0,3 mm



**SIMZ-17-214**  
150 mm

for soft wire up to diam	1,5 mm
for hard wire up to diam	1,0 mm



**SIMZ-17-215**  
160 mm

1,5 mm
1,2 mm



**SIMZ-17-216**  
140 mm  
DUROTIP  
1,5 mm

1,0 mm



**SIMZ-17-217**  
180 mm

for soft wire  
up to diam. 2,0 mm  
For hard wire 1,5 mm  
up to diam  
specially hardened  
cutting edges, front  
and lateral cutting  
action



**SIMZ-17-218**  
REILL  
175 mm

for soft wire  
up to diam. 2,0 mm  
For hard wire 1,6 mm  
up to diam  
specially hardened  
cutting edges, for  
cutting off wires close  
to the bone



**DUROTIP**

**SIMZ-17-219**  
235 mm

for soft wire  
up to diam. 3,0 mm  
For hard wire 2,2 mm  
up to diam



**SIMZ-17-220**  
240 mm

for soft wire  
up to diam. 2.0 mm  
For hard wire  
up to diam. 1.6 mm



**SIMZ-17-221**  
145 mm

for soft wire  
up to diam. 1.5 mm  
For hard wire  
up to diam. 1.0 mm



**SIMZ-17-222**  
145 mm

for soft wire  
up to diam. 2.0 mm  
For hard wire  
up to diam. 1.5 mm



**SIMZ-17-223**  
220 mm

for soft wire  
up to diam. 3.5 mm  
For hard wire  
up to diam. 2.5 mm



**SIMZ-17-224**  
320 mm

for soft wire up to diam. 3,0 mm  
For hard wire up to diam 3,0 mm



Cutter for cutting off KIRSCHNER wires, Tibia head screws, bolts, pins, up to 3 mm diam.



**DUROTIP**

**SIMZ-17-225**  
Cutter for cutting off KIRSCHNER wires, Tibia head screws, bolts, pins, up to 6 mm diam.  
470 mm



**SIMZ-17-226**  
Nail extracting  
forceps  
135 mm



**SIMZ-17-227**  
Nail extracting  
forceps  
145 mm



**SIMZ-17-228**  
Finger nail drill  
with 3 drill points

Drill points only



**SIMZ-17-231**  
Nail splitting  
forceps  
135 mm



**SIMZ-17-232**  
SYSTRUNK  
Scissors, for splitting  
finger nails  
130 mm



**SIMZ-17-233**  
Finger ring saw  
150 mm

Spare blade  
**SIMZ-17-234**



**SIMZ-17-235**  
STILLE-AESCULAP  
260 mm



**SIMZ-17-236**  
STILLE-AESCULAP  
360 mm



**SIMZ-17-237**  
HENING  
270 mm



**SIMZ-17-238**  
MOD.USA  
230 mm



with removable jaws

**SIMZ-17-239**  
290 mm



**SIMZ-17-240 - 17-241**  
WOLFF  
**SIMZ-17-240** 180 mm  
**SIMZ-17-241** 240 mm  
plaster breakers





<p><b>SIMZ-18-101 - 18-106</b> BIEMER SIMZ-18-101 ∅ 4 mm SIMZ-18-102 ∅ 6 mm SIMZ-18-103 ∅ 8 mm SIMZ-18-104 ∅ 10 mm SIMZ-18-105 ∅ 12 mm SIMZ-18-106 ∅ 14 mm Currettes for aspiration lipectomy, graduated, slightly curved</p>	<p><b>SIMZ-18-107 - 18-108</b> BIEMER SIMZ-18-107 ∅ 4 mm SIMZ-18-108 ∅ 6 mm Currettes for aspiration lipectomy, with three apertures, slightly curved malleable</p>	<p><b>SIMZ-18-109 - 18-111</b> BIEMER SIMZ-18-109 ∅ 8 mm SIMZ-18-110 ∅ 10 mm SIMZ-18-111 ∅ 12 mm Currettes for aspiration lipectomy, with three apertures, slightly curved malleable</p>	<p><b>SIMZ-18-112</b> For aspirating fluid from the excretory ducts of large glands and for keeping the operating area clear 170 mm</p>	<p><b>SIMZ-18-113</b> Trocar For puncturing 150 mm</p>	<p><b>SIMZ-18-114</b> For clearing large quantities of fluid 190 mm</p>
---	---	--	---	--	---

**SIMZ-18-115** 150mm  
Suction handle, with vacuum regulator and finger cut-off, brass, mirror-finish chromium-plated



olive  
Ø 9 mm

**SIMZ-18-116** 170mm  
Suction handle, with hand regulation valve and quick-shutter, brass, mirror-finish chromium-plated



Both suction handles have bayonet fitting Olive and can be used for the suction cannulae. Ø 9 mm



**SIMZ-18-117**  
Trocar  
For puncturing  
170 mm



**SIMZ-18-118**  
Hollow needle,  
sharp  
150 mm



**SIMZ-18-119**  
double curved  
For general  
surgery  
230 mm



**SIMZ-18-120**  
For tonsillectomy,  
oral and laryngeal  
operations  
190 mm



**SIMZ-18-121**  
For tonsillectomy,  
oral and laryngeal  
operations  
220 mm

★ With bayonet fitting to be used with suction handles (18-115 - 18-116)

**SIMZ-18-122**  
WULLSTEIN  
Suction tube, conical, silver, olive  
with LUER hub  
160 mm

$\varnothing 1,75$  mm

olive  $\varnothing 8$  mm  $\frac{1}{2}$

**SIMZ-18-123** 1,5 mm  
**SIMZ-18-124** 2,0 mm  
WULLSTEIN  
Suction tube, cylindrical, silver, with  
stylet olive with LUER hub  
160 mm

olive  $\varnothing 8$  mm  $\frac{1}{2}$

Usable length

YASARGIL usable length diam.		YASARGIL usable length diam.	
<b>SIMZ-18-125</b>	130 mm	1,5 mm	<b>SIMZ-18-133</b> 130 mm 2,5 mm
<b>SIMZ-18-126</b>	150 mm	1,5 mm	<b>SIMZ-18-134</b> 150 mm 2,5 mm
<b>SIMZ-18-127</b>	180 mm	1,5 mm	<b>SIMZ-18-135</b> 180 mm 2,5 mm
<b>SIMZ-18-128</b>	220 mm	1,5 mm	<b>SIMZ-18-136</b> 220 mm 2,5 mm
<b>SIMZ-18-129</b>	130 mm	2,0 mm	<b>SIMZ-18-137</b> 130 mm 3,5 mm
<b>SIMZ-18-130</b>	150 mm	2,0 mm	<b>SIMZ-18-138</b> 150 mm 3,5 mm
<b>SIMZ-18-131</b>	180 mm	2,0 mm	<b>SIMZ-18-139</b> 180 mm 3,5 mm
<b>SIMZ-18-132</b>	220 mm	2,0 mm	<b>SIMZ-18-140</b> 220 mm 3,5 mm
			<b>SIMZ-18-141</b> 180 mm 4,5 mm

olive  $\varnothing 6,5-9$  mm with LUER hub  $\frac{1}{2}$

**SIMZ-18-142 - 18-144** LANDOLT  
150 MM  
diam  $\varnothing 3$  mm

**SIMZ-18-142** 8 mm / curved  
**SIMZ-18-143** 11mm / curved  
**SIMZ-18-144** 15mm / curved

$\varnothing 3.5$  mm

$\varnothing 2.0$  mm

**SIMZ-18-145** 500 mm  
**SIMZ-18-146** 350 mm  
with rubber tip,  
with LUER hub

olive  $\varnothing 9$  mm  $\frac{1}{2}$

**SIMZ-18-147** 2,0 mm diam  
**SIMZ-18-148** 2,5 mm diam  
**SIMZ-18-149** 3,0 mm diam  
with finger cut-off,  
thumb piece 90° to  
curve, with LUER hub  
250 mm

olive  $\varnothing 6-9$  mm  $\frac{1}{2}$

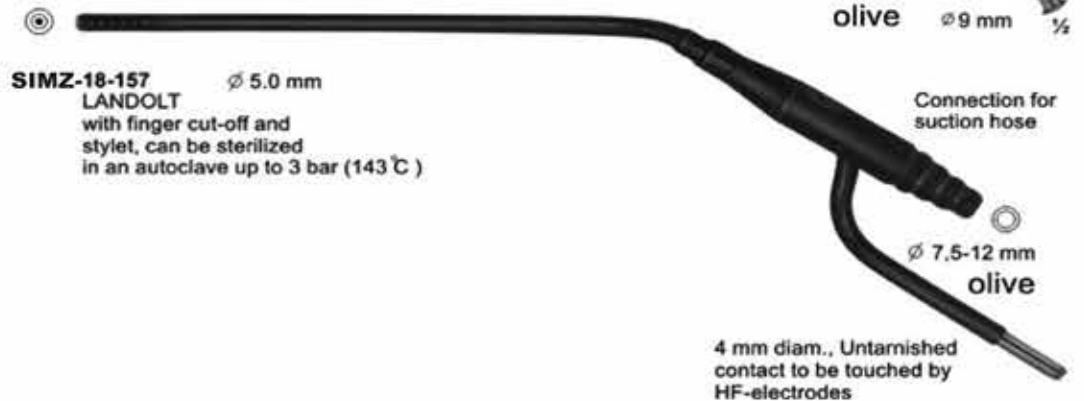
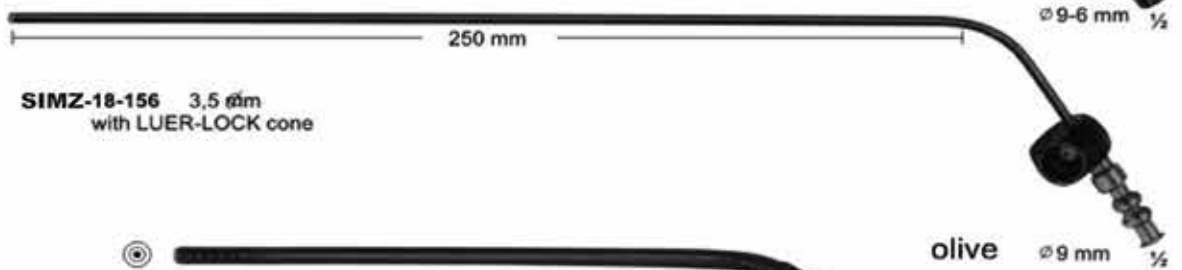
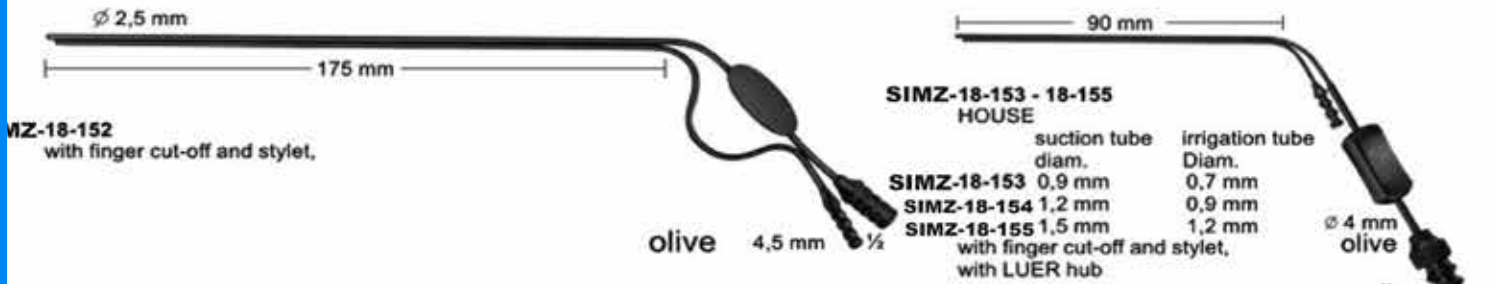

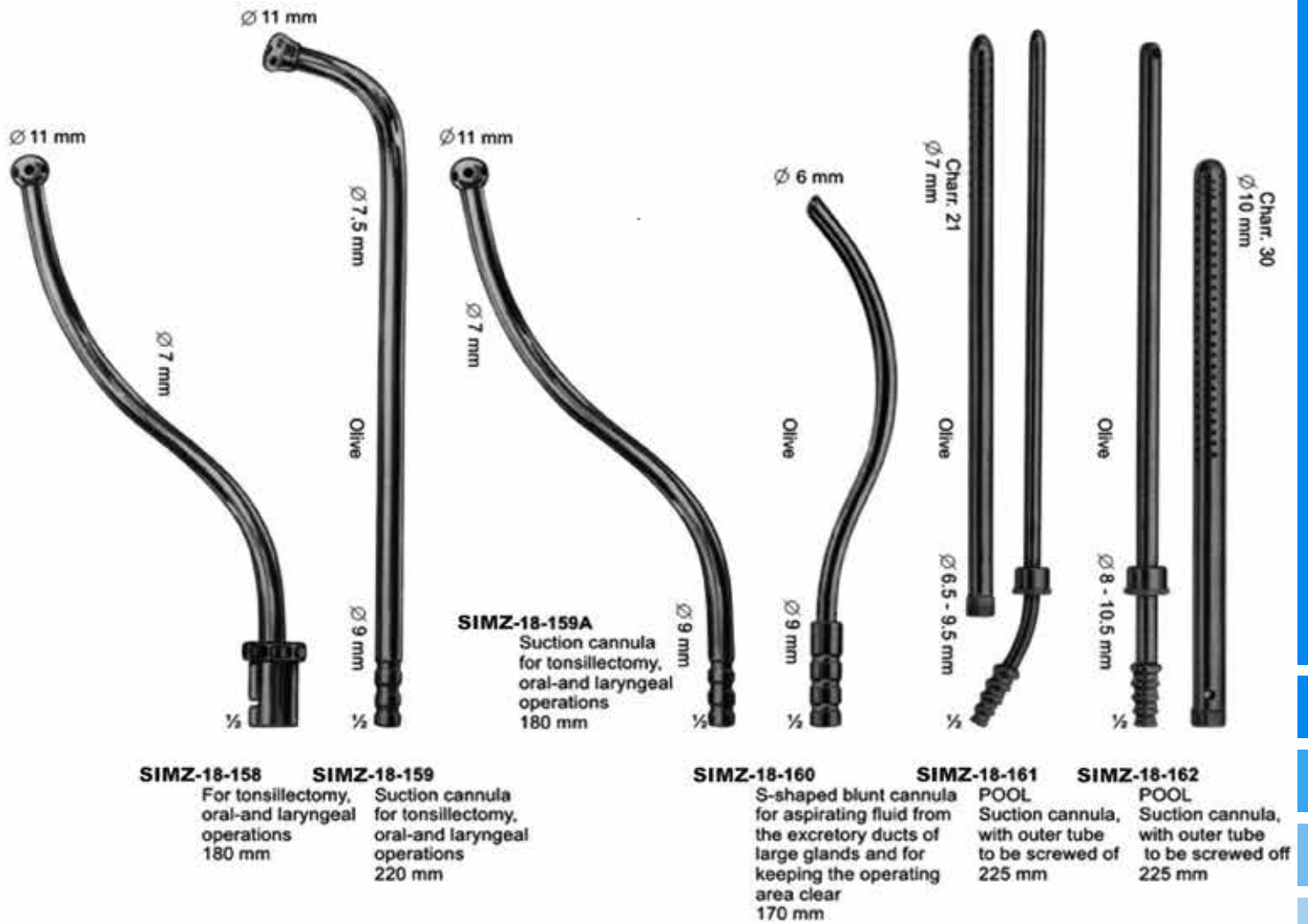

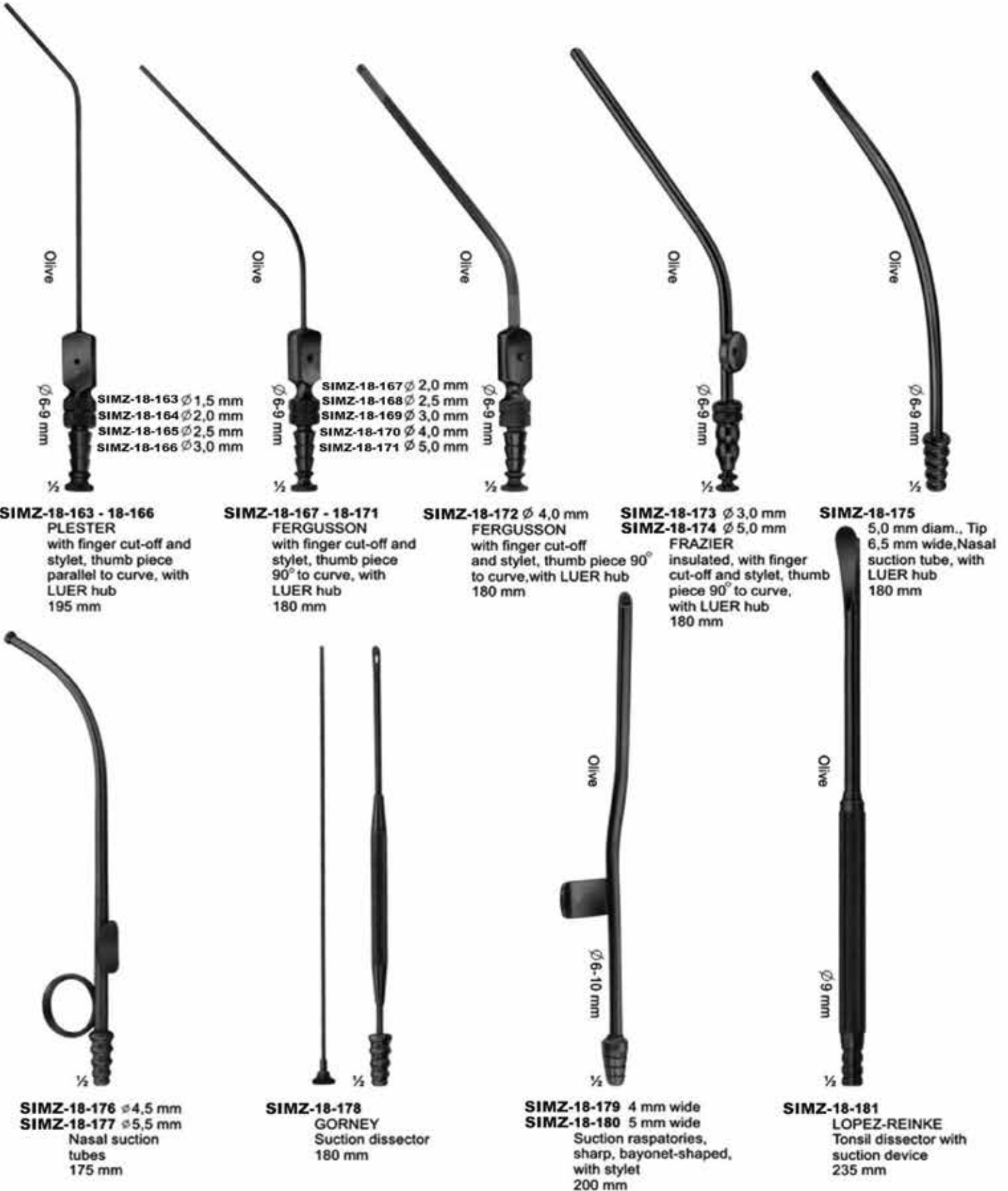



**SIMZ-18-182**

- 1- Blow pipe .
- 2- 3 PCS .scalpel.
- 3- Dissecting forcep 13 cm.
- 4- Grooved director with tounge tie 13 cm.
- 5- Triple chain hook.
- 6- Dressing scissors probe pointed 13 cm.
- 7- Probe double 13 cm.
- 8- Zipper case inside red velvet.



**SIMZ-18-183**

- 1- Probe Double 13 cm
- 2- 2 PCS. Scalpel S.S
- 3- Grooved Director With tongue Tie 13 cm
- 4- Mayo Hegar Needle Holder 13cm
- 5- Disscting Forcep 13 cm 1x2 Teeth
- 6- Dressing Forcep 13 CMS Serrated.
- 7- Dressing Scissor 13 cm S/B STR.
- 8- Dressing Scissor 13 cm S/B CVD.
- 9- Zipper Case Inside Red Velvet.

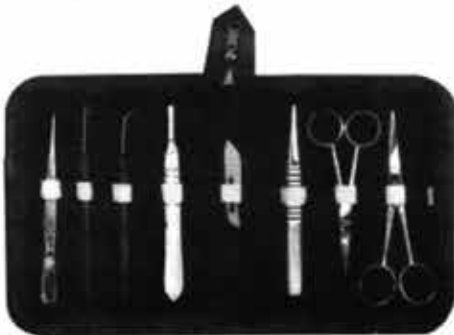

**SIMZ-18-184**

- 1- Dissecting Forcep 11.5 cm Sharp Point.
- 2- Iris Scissor
- 3- B.P Handle No. 4
- 4- Teasing Needle Sharp angular.
- 5- Blade No. 22
- 6- Thumb Forceps T.O.E 13 cm
- 7- Dissecting Scissor STR 11.5 cm
- 8- Dissecting Scissor STR 13 cm
- 9- Zipper case Inside Red Velvet



**SIMZ-18-185**

- 1- Grooved Director with Tongue Tie 14 cm
- 2- Probe Double 14cm
- 3- Mayo Hegar Needle Holder 14 cm
- 4- BP. Handle no.3
- 5- BP. Handle no.4
- 6- Dressing Scissor 14 cm S/B STR
- 7- Dressing Scissor 14 cm S/B CVD.
- 8- Dressing Forcep 1x2 Teeth 14 cm
- 9- Dressing Forcep Serrated 14 cm



**SIMZ-18-186**

- 1- Probe double 12.5 cm
- 2- Scalpel
- 3- B.P Handle No. 4
- 4- 6 PCS Blade 2 each no. 21, 22, 23
- 5- Dissecting Forcep 12.5 cm
- 6- Dissecting Forcep 11.5 cm sharp Point.
- 7- Dissecting Scissor S/B STR 13 cm
- 8- Dissecting Scissor S/S STR 13 cm



**SIMZ-18-187**

- 1- Teasing Needle with Chuck CVD.
- 2- Huber Probe
- 3- Iris Scissor
- 4- Dissecting Forcep Fine 14 cm.
- 5- Dissecting Forcep Fine CVD. 12 cm
- 6- Operating Scissor with Probe 14 cm.
- 7- B.P. Handle no. 4



**SIMZ-18-188**

- 1- Probe with eye
- 2- Dissecting Forcep cvd fine 12 cm.
- 3- Iris Scissor
- 4- Operating Scissor S/B str 14 cm
- 5- Grooved Director and Tongue tie
- 6- Huber Probe
- 7- Triple Chain Hook
- 8- B.P Handle No. 4
- 9- B.P Handle No. 3
- 10- Teasing Needle with Chuck cvd.
- 11- Teasing Needle with Chuck str.
- 12- Dissecting Forceps Fine 14 cm.



**SIMZ-18-189**

- 1- Grooved Director and Tongue tie
- 2- Mayo Hearg Needle Holder 14 cm
- 3- B.P Handle No. 4
- 4- Dissecting Forceps Thump 14 cm.
- 5- Operating Scissor S/B str 14 cm
- 6- Kelly Forcep STR 14 cm.
- 7- Probe Double end



**SIMZ-18-190**

- 1- Iris Scissor STR
- 2- Dissecting Forceps CVD 12 cm.
- 3- Scapel
- 4- Teasing Needle STR wooden handle.
- 5- Teasing Needle CVD wooden handle.
- 6- Watchmaker fine point.



**SIMZ-18-191**

- 1- Probe Double end
- 2- B.P Handle No. 4
- 3- Dissecting Forcep 1x2 Teeth 14 cm.
- 4- Operating Scissor S/B str 14 cm
- 5- Mayo Hearg Needle Holder 14 cm
- 6- Kelly Forcep STR 14 cm.
- 7- Operating Scissor S/B CVD 14 cm
- 8- Grooved Director and Tongue tie
- 9- Dissecting Forceps Thumb 14 cm.



**SIMZ-18-192**

- 1- Probe double end.
- 2- Grooved director and tounge tie.
- 3- B.P handle no.4
- 4- Operating scissor STR S/b14cm.
- 5- Kelly forceps STR 14cm.
- 6- Dissecting forceps thumb 13cm.



**SIMZ-18-193**

- 1- Dissecting Forceps Thumb 14 cm
- 2- Dissecting Forcep 1x2 Teeth 14 cm.
- 3- B.P Handle No. 3
- 4- Grooved Director and Tongue tie
- 5- Mayo Hearg Needle Holder 14 cm
- 6- Operating Scissor S/B str 14 cm
- 7- Probe Double end
- 8- Kelly Forcep STR 14 cm.





### SIMZ-18-194

- 1- Dissecting Forcep Fine 14cm.
- 2- Dissecting Forcep Fine CVD 12cm
- 3- Dissecting Forcep with Pin 14cm.
- 4- Watchmaker Fine point
- 5- Iris scissor STR
- 6- Iris scissor CVD.
- 7- Teasing Needle holder
- 8- Teasing Needle STR.
- 9- B.P. Handle no. 3



### SIMZ-18-195

- 1- Teasing Needle STR.
- 2- Grooved Director and Tongue Tie.
- 3- Teasing Needle CVD.
- 4- Dissecting Forcep with Pin 12 cm Fine
- 5- Operating Scissor S/B STR 14 cm
- 6- Triple Chain Hook
- 7- Probe with eye
- 8- Probe Double end
- 9- Probe and Hook
- 10- Dissecting Forcep Fine 14 cm
- 11- Iris Scissor
- 12- Huber Probe
- 13- B.P. Handle no.3
- 14- B.P. Handle no.4



### SIMZ-18-196

- 1- Dissecting forcep fine STR with pin 12cm.
- 2- Iris scissor STR.
- 3- Probe with eye.
- 4- Probe and hook.
- 5- Operating scissor S/B STR 14cm
- 6- Triple chain hook.
- 7- B.P. handle no.4
- 8- Humber probe.
- 9- B.P.handle no.3
- 10- Teasing needle STR plastic handle.
- 11- Teasing needle CVD plastic handle.
- 12- Grooved director and tongue tie.
- 13- Probe double end.



### SIMZ-18-197

- 1- Dissecting Forceps Thumb 14 cm.
- 2- Dissecting Forcep 1x2 Teeth 14 cm.
- 3- B.P Handle No. 3
- 4- Grooved Director and Tongue tie
- 5- Mayo Hearn Needle Holder 14 cm
- 6- Operating Scissor S/B str 14 cm
- 7- Probe Double end
- 7- Kelly Forcep STR 14 cm.



**SIMZ-19-101 - 115**  
Schimmelbusch

	∅ x H sizes in mm
<b>SIMZ-19-101</b>	80 x 80
<b>SIMZ-19-102</b>	105 x 120
<b>SIMZ-19-103</b>	140 x 140
<b>SIMZ-19-104</b>	160 x 120
<b>SIMZ-19-105</b>	160 x 150
<b>SIMZ-19-106</b>	190 x 150
<b>SIMZ-19-107</b>	190 x 190
<b>SIMZ-19-108</b>	240 x 160
<b>SIMZ-19-109</b>	240 x 240
<b>SIMZ-19-110</b>	290 x 160
<b>SIMZ-19-111</b>	290 x 240
<b>SIMZ-19-112</b>	340 x 160
<b>SIMZ-19-113</b>	340 x 340
<b>SIMZ-19-114</b>	390 x 190
<b>SIMZ-19-115</b>	390 x 290



**SIMZ-19-116**  
Box  
120 x 65 x 13 mm  
(without Bulldog clamps,  
without silicone tape)



**SIMZ-19-117**  
Box with support  
120 x 65 x 13 mm  
(ohne Bulldogklemmen)



**SIMZ-19-118**  
Box with support for  
needle electrodes,  
without instruments



**SIMZ-19-119 - 121**  
50 x 25 x 4,5 mm  
**SIMZ-19-120**  
65 x 42 x 8 mm  
**SIMZ-19-121**  
75 x 25 x 4,5 mm



**SIMZ-19-122**  
∅ 65mm x 15mm



**SIMZ-19-123 - 131**

	Ø x H
<b>SIMZ-19-123</b>	30 x 90 mm
<b>SIMZ-19-124</b>	50 x 100 mm
<b>SIMZ-19-125</b>	50 x 130 mm
<b>SIMZ-19-126</b>	50 x 175 mm
<b>SIMZ-19-127</b>	75 x 100 mm
<b>SIMZ-19-128</b>	75 x 130 mm
<b>SIMZ-19-129</b>	75 x 175 mm
<b>SIMZ-19-130</b>	100 x 175 mm
<b>SIMZ-19-131</b>	100 x 200 mm



**SIMZ-19-141 - 142**

- SIMZ-19-141** Martin Sterilizing Forceps consisting of:  
 1 Sterilizing Forceps, curved, 25 cm, without ratchet, with lid for jar  
 1 jar with bottom plate (anti-tilt)
- SIMZ-19-142** ditto, with 32 cm long Sterilizing Forceps



**SIMZ-19-132 - 139**

<b>SIMZ-19-132</b>	165 x 85 x 35 mm
<b>SIMZ-19-133</b>	200 x 100 x 35 mm
<b>SIMZ-19-134</b>	200 x 100 x 50 mm
<b>SIMZ-19-135</b>	230 x 130 x 50 mm
<b>SIMZ-19-136</b>	260 x 150 x 50 mm
<b>SIMZ-19-137</b>	270 x 235 x 50 mm
<b>SIMZ-19-138</b>	300 x 200 x 50 mm
<b>SIMZ-19-139</b>	325 x 275 x 50 mm



**SIMZ-19-140**  
 205 x 105 x 35 mm



**SIMZ-19-143 - 148**

	Ø x H
<b>SIMZ-19-143</b>	75 x 60 mm
<b>SIMZ-19-144</b>	75 x 75 mm
<b>SIMZ-19-145</b>	100 x 60 mm
<b>SIMZ-19-146</b>	100 x 100 mm
<b>SIMZ-19-146A</b>	125 x 80 mm
<b>SIMZ-19-147</b>	125 x 125 mm
<b>SIMZ-19-148</b>	150 x 150 mm



**SIMZ-19-149**  
25 cc

**SIMZ-19-150**  
50 cc



**SIMZ-19-117**

**SIMZ-19-151**  
20 cc  
Medicine Spoon



**SIMZ-19-152**  
Ø 75 x 12 mm  
Tablet Tray



**SIMZ-19-153**  
Ø 90 x 90 mm  
Metal Cup



**SIMZ-19-154**  
Ø 75 x 80 mm  
Sputum Cup



**Kidney Dish**



**SIMZ-19-155 - 157**

<b>SIMZ-19-155</b>	170 x 100 x 35 mm
<b>SIMZ-19-156</b>	250 x 140 x 40 mm
<b>SIMZ-19-157</b>	275 x 150 x 45 mm



**SIMZ-19-158 - 165**



**SIMZ-19-166 - 170**

	∅ x H	
<b>SIMZ-19-158</b>	40 x 19 mm	0.05L
<b>SIMZ-19-159</b>	61 x 30 mm	0.07L
<b>SIMZ-19-160</b>	80 x 40 mm	0.14L
<b>SIMZ-19-161</b>	116 x 50 mm	0.35L
<b>SIMZ-19-162</b>	128 x 55 mm	0.45L
<b>SIMZ-19-163</b>	147 x 65 mm	0.70L
<b>SIMZ-19-164</b>	167 x 75 mm	1.10L
<b>SIMZ-19-165</b>	187 x 85 mm	1.60L

<b>SIMZ-19-166</b>	116 x 35 mm	0.30L
<b>SIMZ-19-167</b>	128 x 38 mm	0.40L
<b>SIMZ-19-168</b>	147 x 40 mm	0.50L
<b>SIMZ-19-169</b>	157 x 45 mm	0.75L
<b>SIMZ-19-170</b>	187 x 45 mm	1.00L



**SIMZ-19-171**  
∅ 110 x 28 mm 0.15L



**SIMZ-19-172**  
100 cc 0.1L



**SIMZ-19-173 - 176**  
**SIMZ-19-173** 0.25L  
**SIMZ-19-174** 0.50L  
**SIMZ-19-175** 1.00L  
**SIMZ-19-176** 2.00L



**SIMZ-19-177**  
235 x 190 x 40 mm



**SIMZ-19-178**  
∅ 220 x 70 mm



**SIMZ-19-179**  
 ∅ 50 x 100 mm  
 Powder Pot



**SIMZ-19-180**  
 ∅ 50 x 75 mm  
 Methot With Lid



**SIMZ-19-181**  
 ∅ 50 x 75 mm  
 Methot Without Lid



**SIMZ-19-182**



**SIMZ-19-183**



**SIMZ-19-184**



**SIMZ-19-185 - 186**

**SIMZ-19-185** ∅ 235 mm  
**SIMZ-19-186** ∅ 310 mm



**SIMZ-19-187**  
Sauerbruch  
210 x 125 x 17 mm



**SIMZ-19-188**  
Sauerbruch  
210 x 125 x 17 mm



**SIMZ-19-189**  
150 x 95 x 13 mm



**SIMZ-19-190**  
150 x 95 x 13 mm



**SIMZ-19-191**  
150 x 95 x 13 mm



**SIMZ-19-192**  
150 x 95 x 13 mm



**SIMZ-19-193**  
150 x 95 x 13 mm



**SIMZ-19-194**  
150 x 95 x 13 mm



**SIMZ-19-195**  
150 x 95 x 11 mm



**SIMZ-19-199 - 209**

<b>SIMZ-19-199</b>	230 x 130 x 50	mm
<b>SIMZ-19-200</b>	260 x 150 x 50	mm
<b>SIMZ-19-201</b>	275 x 235 x 50	mm
<b>SIMZ-19-202</b>	300 x 200 x 50	mm
<b>SIMZ-19-203</b>	325 x 275 x 50	mm
<b>SIMZ-19-204</b>	420 x 175 x 50	mm
<b>SIMZ-19-205</b>	230 x 130 x 75	mm
<b>SIMZ-19-206</b>	260 x 150 x 75	mm
<b>SIMZ-19-207</b>	300 x 200 x 75	mm
<b>SIMZ-19-208</b>	325 x 275 x 75	mm
<b>SIMZ-19-209</b>	420 x 175 x 75	mm



**SIMZ-19-196**  
Deponette  
245 x 135 x 35mm



**SIMZ-19-197**  
Deponette  
245 x 135 x 50mm



**SIMZ-19-198**  
Deponette  
245 x 135 x 60mm





**SIMZ-19-210 - 212**

<b>SIMZ-19-210</b>	480 x 250 x 50	mm
<b>SIMZ-19-211</b>	520 x 250 x 75	mm
<b>SIMZ-19-212</b>	520 x 250 x 100	mm



**SIMZ-19-219**  
(60 x 30 x 15 cm)  
Nominal dimensions



**SIMZ-19-213 - 218**

<b>SIMZ-19-213</b>	240 x 240 x 50	mm
<b>SIMZ-19-214</b>	240 x 240 x 80	mm
<b>SIMZ-19-215</b>	240 x 240 x 100	mm
<b>SIMZ-19-216</b>	480 x 260 x 50	mm
<b>SIMZ-19-217</b>	520 x 260 x 80	mm
<b>SIMZ-19-218</b>	520 x 260 x 100	mm



**SIMZ-26-101**  
Standard

14,5cm  
16,5cm  
18,5cm



**SIMZ-26-102**  
Standard

14,5cm  
16,5cm  
18,5cm



**SIMZ-26-103**  
Standard

14,5cm  
16,5cm  
18,5cm



**SIMZ-26-104**  
Standard

14,5cm  
16,5cm  
18,5cm



**SIMZ-26-105**  
Standard

14,5cm  
16,5cm  
18,5cm



**SIMZ-26-106**  
Standard

14,5cm  
16,5cm  
18,5cm

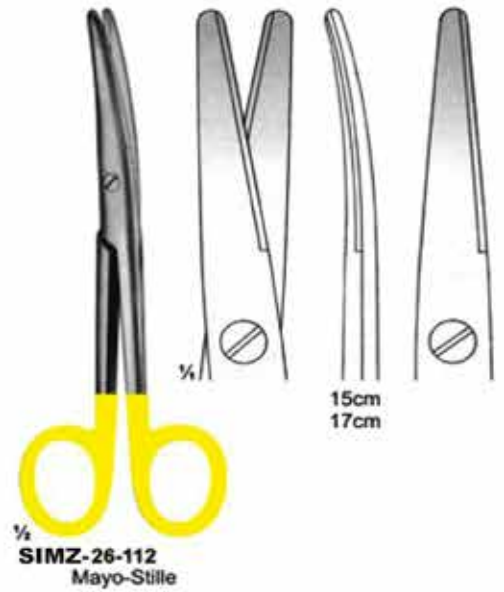
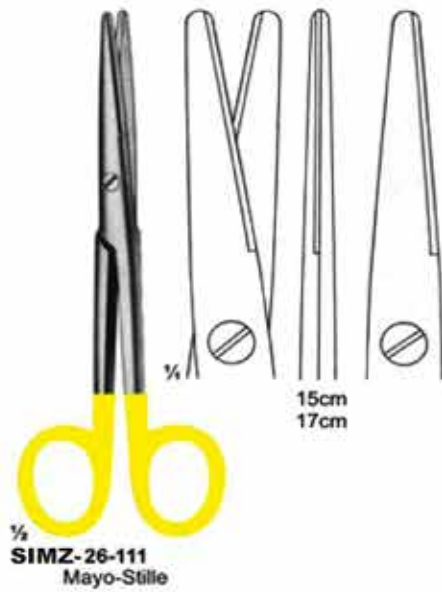
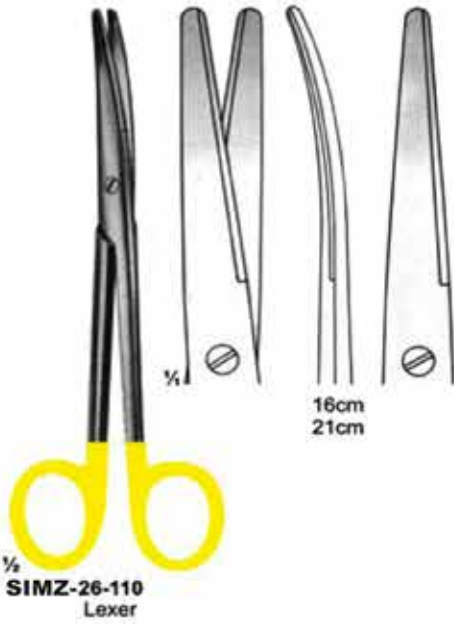
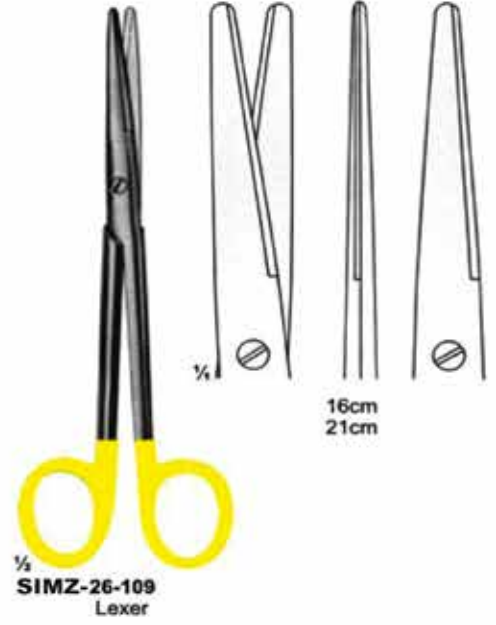
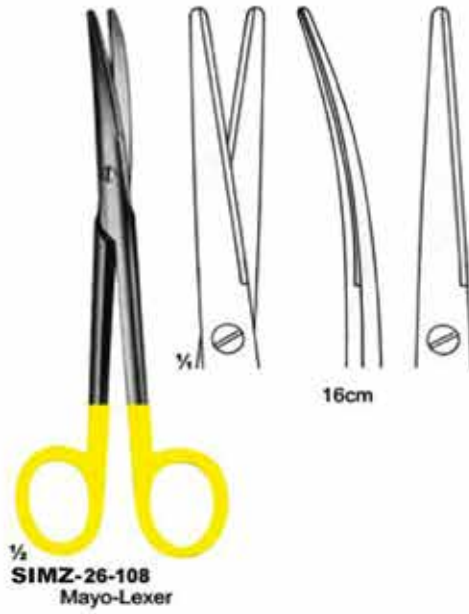
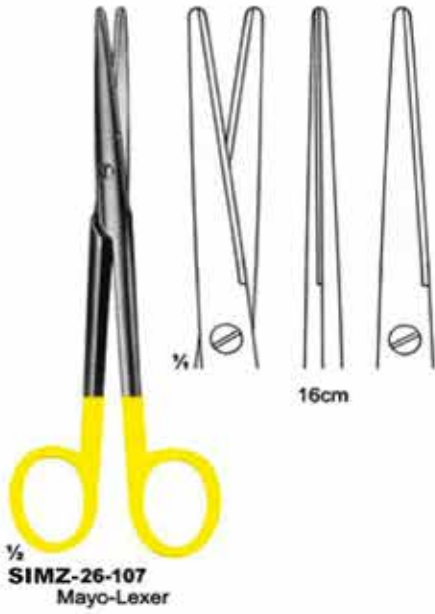



1/2  
**SIMZ-26-113**  
Metzenbaum

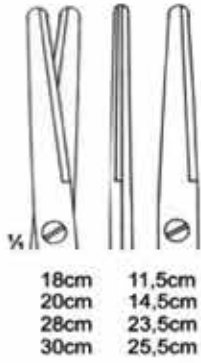

18cm 11,5cm  
20cm 14,5cm  
28cm 23,5cm  
30cm 25,5cm



1/2  
**SIMZ-26-114**  
Metzenbaum



11,5cm 14,5cm  
23cm 25cm



1/2  
**SIMZ-26-115**  
Metzenbaum



18cm 20cm  
28cm 30cm



1/2  
**SIMZ-26-116**  
Metzenbaum-Fino

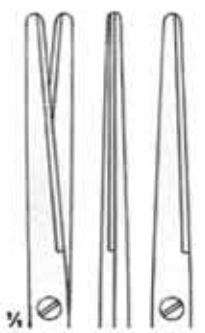

14cm 18cm 20cm  
23cm 25cm 28cm



1/2  
**SIMZ-26-117**  
Metzenbaum-Fino

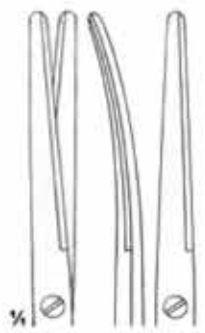

14cm 18cm 20cm  
23cm 25cm 28cm



1/2  
**SIMZ-26-118**  
Metzenbaum-Fino



14cm 18cm  
20cm 23cm

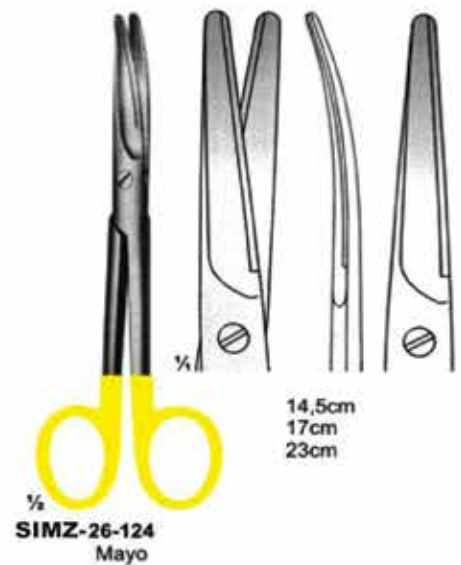
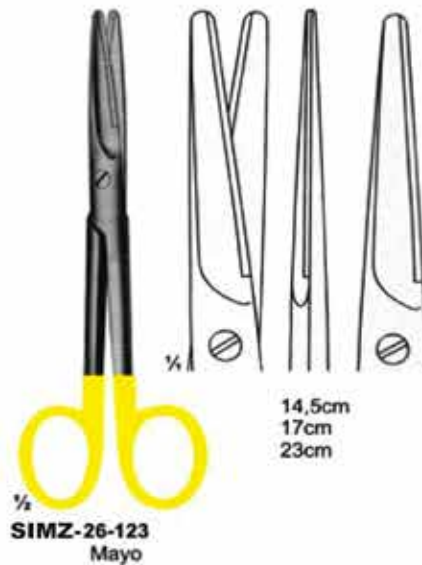
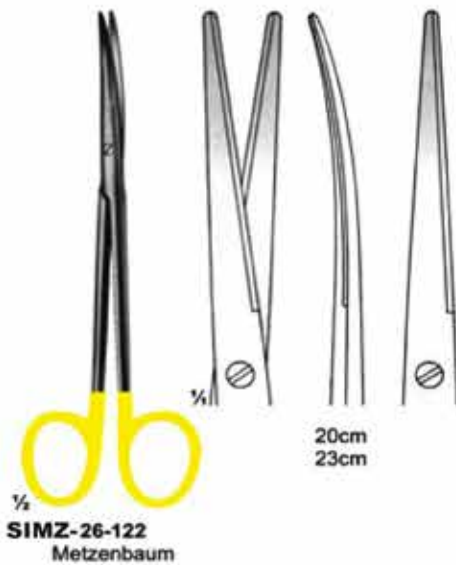
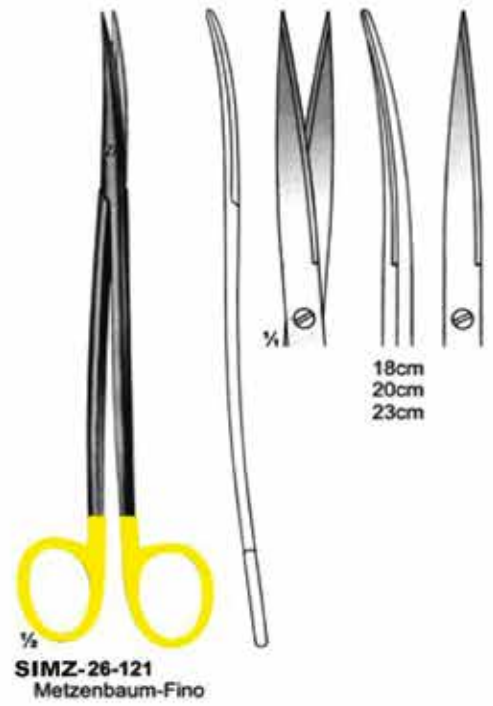
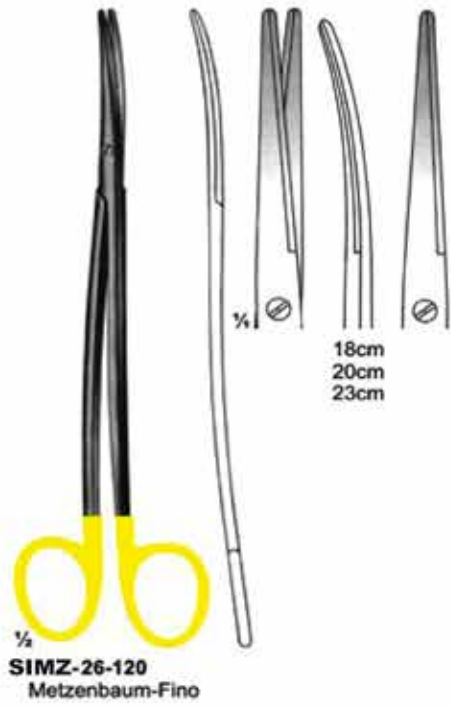

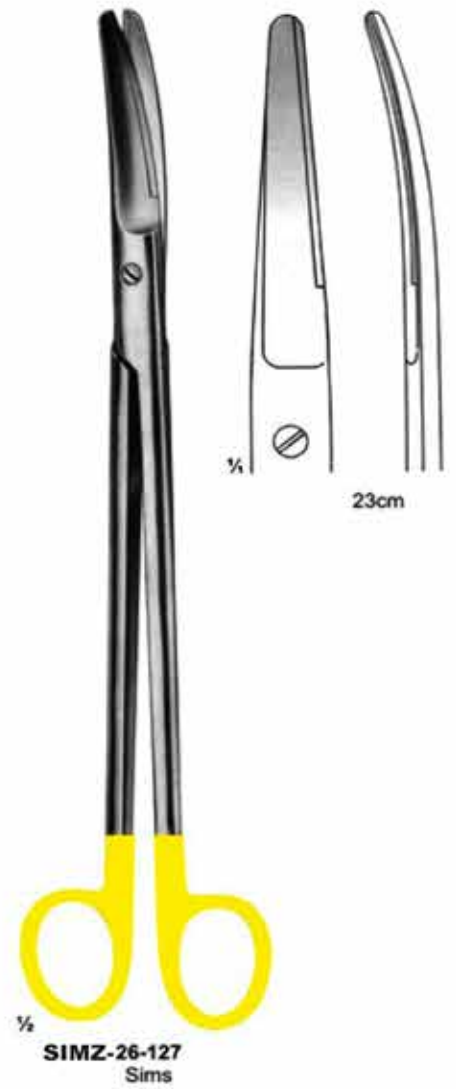
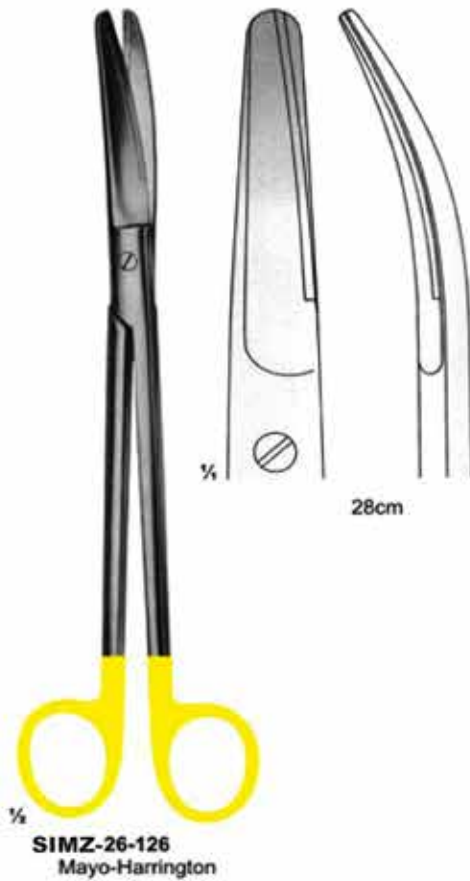
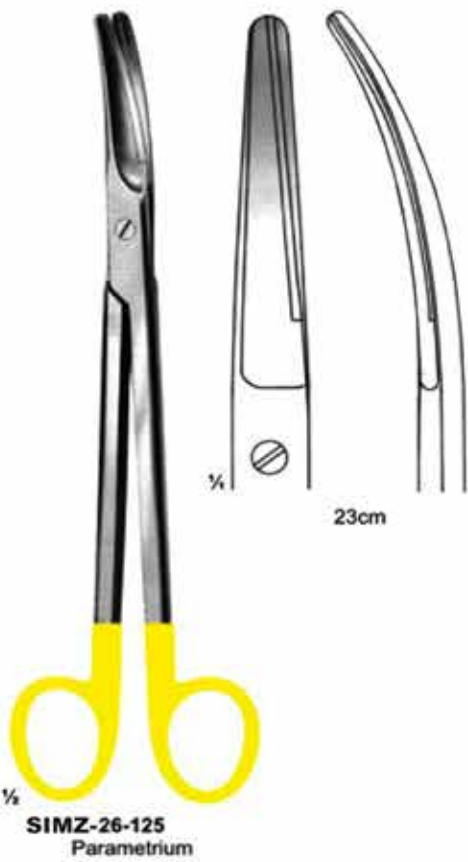

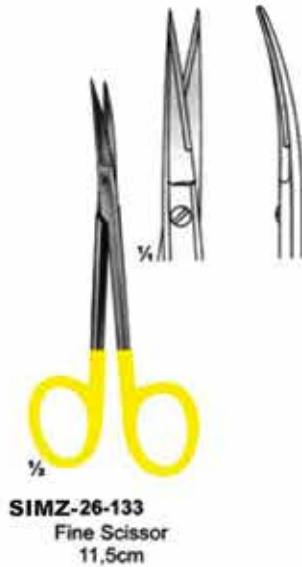
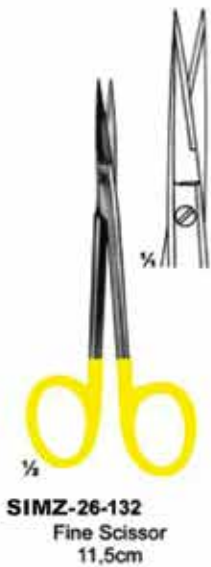
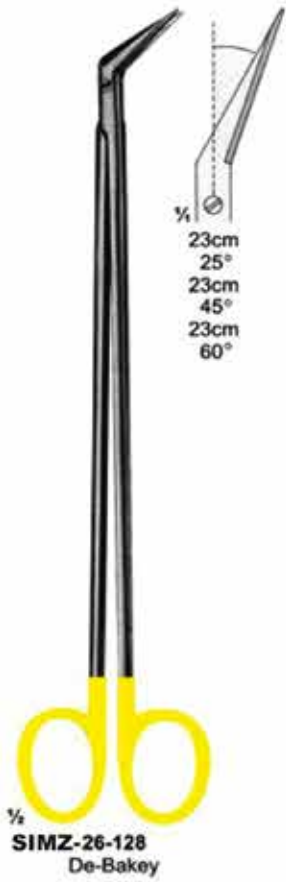



**SIMZ-26-136**  
Universal  
12cm



**SIMZ-26-137**  
Ligature Scissors  
1 Black & 1 Goldplated ring



**SIMZ-26-138**  
Adson



**SIMZ-26-139**  
Cushing  
17,5cm



**SIMZ-26-140**  
Cushing  
18cm



**SIMZ-26-141**  
Cushing-Taylor  
18cm



**SIMZ-26-142**  
Dissecting Forceps  
15cm



**SIMZ-26-143**  
Semken  
15cm





**SIMZ-26-144**  
Wangenstein

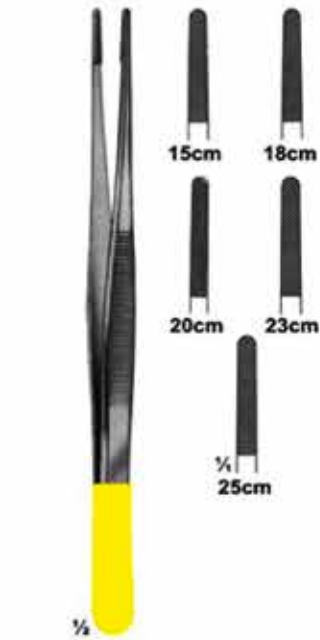

**SIMZ-26-145**  
Potts-Smith

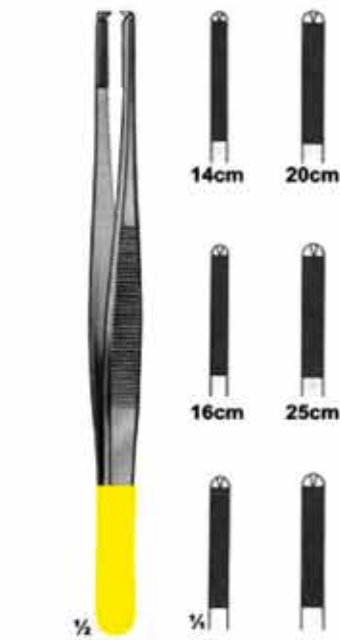

**SIMZ-26-146**  
Oehler



**SIMZ-26-147**  
Potts-Smith  
22cm



**SIMZ-26-148**  
Hepp-Scheidle  
18cm



**SIMZ-26-149**  
Castroviejo  
14cm



**SIMZ-26-150**  
Castroviejo  
14cm



**SIMZ-26-151**  
Arruga  
16cm



**SIMZ-26-152**  
Arruga  
16cm



**SIMZ-26-153**  
Castroviejo  
13cm



**SIMZ-26-154**  
Hegar  
20cm 24cm



**SIMZ-26-155**  
Halsey  
13cm 15cm



**SIMZ-26-156**  
Mayo-Hegar  
16cm 18cm 20cm  
24cm 26cm 30cm



**SIMZ-26-157**  
De-Bakey  
18cm 20cm 23cm  
26cm 31cm 37cm



**SIMZ-26-158**  
Hegar-Vascular  
14cm 18cm  
20cm 23cm



$\frac{1}{4}$  **SIMZ-26-159**  
Bozemann-Wertheim  
20cm 24cm 26cm



$\frac{1}{4}$  **SIMZ-26-160**  
Stratte  
22cm 23cm



$\frac{1}{4}$  **SIMZ-26-161**  
Ryder  
13cm 15cm 18cm  
20cm 23cm 26cm



$\frac{1}{4}$  **SIMZ-26-162**  
Ryder-Vascular  
13cm 15cm 18cm  
20cm 23cm 26cm



$\frac{1}{4}$  **SIMZ-26-163**  
Martin  
15cm 17cm 20cm



$\frac{1}{4}$  **SIMZ-26-164**  
Sarot  
18cm 20cm 26cm





1/2  
**SIMZ-26-172**  
Mathieu-Ryder  
17cm  
20cm 24cm



1/2  
**SIMZ-26-173**  
Lichtenberg  
20cm



1/2  
**SIMZ-26-174**  
Langhals  
20cm 25cm



1/2  
**SIMZ-26-175**  
Lichtenberg  
20cm 25cm



1/2  
**SIMZ-26-176**  
Luehty-Beck  
20cm 25cm



1/2  
**SIMZ-26-177**  
Luehty-Beck  
20cm 25cm



1/2  
**SIMZ-26-178**  
Langebeck  
18cm  
20cm 23cm



1/2  
**SIMZ-26-179**  
Langebeck-beck  
18cm  
20cm 23cm



**SIMZ-26-180**  
**TOENNIS**  
 Elastic pattern for  
 dura-or intestinal suture  
 180 mm



**SIMZ-26-181**  
 Cutting Plier  
 12 cm



**SIMZ-26-182**  
**MULLAR CLAUS**  
 22 cm

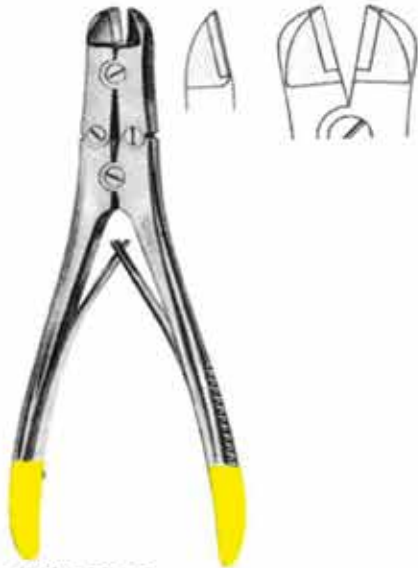
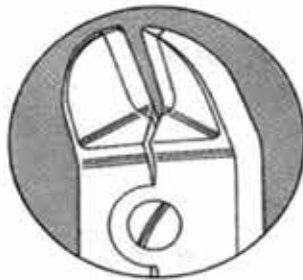

**SIMZ-26-183**  
 Plier  
 17.5 cm

<b>A</b>			
ABRAHAM, tonsil knife	13	BRUNS, plaster scissor	64
ADSON, forceps	33	BRYANT, sponge forceps	43
ADSON, forceps	37	BROPHY, Tissue Forceps	38
ALLIS, artery traction forceps	47	BROWN, Tissue Forceps	39
ALLIS, intestinal grasping forceps	86	BUCHS, retractors	75
ALY, aesthesiometer	01	BUCHWALD, tongue depressor	04
AMPUTATING KNIVES	12	BUCK, neurological hammer	01
ANDREW, tongue depressor	04	BUMM, ovum forceps	230
ANESTOPHON, stethoscope	02	BUCK, Ear Curettes	110
ARRUGA, forceps	37		
ARRUGA, needle holder	61	<b>C</b>	
ASCH, biopsy curettes	112	CASPAR, retractor	75
AUFRICHT, rasps	138	CASPAR, Micro scissor 115mm	16
AYRE, cone knife, 235mm	13	CASTROVIEJO, tissue forceps	37
ADSON - BROWN, Tissue Forceps	39	CASTROVIEJO, micro spring scissor	15
ADSON, Haemostatic Forceps	52	CASTROVIEJO, needle holder	61
ANGLE, Wire Cutters Cutting Scissors	151	CASTROVIEJO, eye scissor 110mm	15
		CASTROVIEJO, eye scissor 115mm	15
		CATLIN, amputating knife 160mm	12
<b>B</b>		CALIPER, Examination & Measuring Instruments	10
BABCOCK, intestinal grasping forceps	86	CARREL, Haemostatic Forceps	51
BABY-ALLIS, artery traction forceps	47	CARROLL, Examination & Measuring Instruments	10
BACKHAUS, towel clamps	48	CASPAR, Rongeurs	133
BACKHAUS-KOCHER, towel clamps	48	CASPAR, Rongeurs	134
BAILEY, rib spreaders	128	CASTROVIEJO, Examination & Measuring Instruments	10
BAKES, gall duct dilators	95	CHAPUT, artery traction forceps	47
BALFOUR, abdominal retractors	85	CLOWARD, lamina Spreaders	83
BALFOUR-BABY, abdominal retractors	84	CLAUS PLIER, Wire Cutting Plier With T.C. Inserts	187
BANE-HARTMANN, bone rongeurs	144	CLAUS PLIER, Wire Cutting Plier With T.C. Inserts	187
BARTH, bone curettes	139	COAKLEY, antrum trocars	100
BABY-MOSQUITO, Haemostatic Forceps	51	COLLIN, intestinal grasping forceps	86
BABY-ROUX, Retractors	73	COLLIN, rib shears	126
BABY-SENN-MILLER, Retractors	73	COLLIN, sponge and dressing forceps	44
BEEBE wire scissor	29	COLLIN, tongue forceps	05
BEER, cilia forceps	42	COLLIN, vaginal spatula	101
BENGOLEA, delicate forceps	50	CONE KNIFE 235mm11	13
BERGER, biopsy forceps	115	CONVERSE, fine wound retractor	69
BERLINER, percussion hammer	01	COOLEY, multi purpose clamps	122
BENDING PLIERS, Wire Holding forceps	150	COTTLE, retractors	71
BERTILLON, Examination & Measuring Instruments	10	COTTLE, nasal scissor	25
BIEMER, vein scissor	16	COTTLE, fine wound retractor	69
BISHOP-HARMON, forceps	37	COTTLE, mallets	140
BIEMER, Suction Instruments	158	COLLIN, Examination & Measuring Instruments	10
BLAKE, gall stone forceps	96	COLLIN, Intestinal Grasping Forceps	46
BLUMENTHAL, bone rongeurs	144	COLLIN, Retractors	73
BONNEY, tissue forceps	41	COLLIN-HARTMANN, Retractors	73
BOSE, tracheal hooks	119	COTTLE, Forceps, Bayonet – Shaped	40
BOWLES, stethoscope	02	COTTLE, Nasal Specula	91
BOYS-ALLIS, artery traction forceps	47	CRILE, Haemostatic Forceps	52
BOZEMANN, dressing forceps	108	CRILE, Haemostatic Forceps	52
BOYNTON, Needle Holders	47	CRILE, Retractors	73
BRAUN, artery traction forceps	107	CUTTING PLIER, Wire Cutting Plier With T.C. Inserts	187
BRAUN, uterine probes	28	CRAFOORD, haemostatic forceps	50
BRAUN-STADLER episiotomy scissor	31	CRILE, needle holder	63
BRAUN-STADLER, bandage scissors	102	CUSCO, vaginal specula	101
BRIESKY, vaginal specula	66	CUSHING, wound and vein retractor	71
BRODIE, probes	34	CUSHING, dissecting forceps	34
BROPHY, dissecting forceps	04	CUSHING-KOCHER, retractors	71
BRUENINGS, tongue depressor	13	CZERNY, gall stone forceps	96
BRUNINGS, tonsil knife, 215mm	76	CZERNY, retractors	72
BRUNNER, retractors	126		
BRUNNER, rib shears	31		

<b>D</b>		<b>F</b>	
DAVIDSON, scapula retractors	77	FARABEUF, Retractors	73
DAVIS, vascular spatulas	120	FEILCHENELD, splinter forceps	42
DANDY, Haemostatic Forceps	51	FERGUSSON, haemorrhoidal forceps	93
DE BAKEY, forceps	36	FERGUSSON, suction instrument	163
DE BAKEY, anastomosis clamps	89	FERGUSSON-ACKLAND, mouth gag	05
DE BAKEY, anastomosis clamps	125	FINOCHIETTO, forceps	58
DE BAKEY, arteriotomy scissor	22	FINOCHIETTO, rib spreader	127
DE BAKEY, vana cava clamps	123	FINSEN, tracheal hooks	119
DE BAKEY, multi purpose clamps	122	FIBER OPTIC, laryngoscopes	09
DE BAKEY, retractors	82	FINGER NAIL DRIL, Finger Nail Instruments	155
DE BAKEY, atraumata	121	FINGER RING SAW, Finger Nail Instruments	155
DEAN, nasal and tonsil scissor	25	FINSTERER, Suction Instruments	161
DEAVER, retractors	77	FLAT-NOSED PLIERS, Wire Holding forceps	150
DEAVER, surgical scissor (flat lock)	21	FOERSTER-BALLENGER, Tissue Grasping Forceps	45
DE-BAKEY, bulldog clamps	49	FORCEPS, Finger Nail Instruments	155
DEJERINE, percussion hammer	01	FOREGGER, laryngoscopes	09
DELICATE DISSECTING FORCEPS	33	FOMON, nasal scissor	19
DELICATE SCISSORS, blunt points	19	FORD-BOWLES, stethoscope	02
DELICATE SCISSORS, sharp points	18	FOWLER, tonsil knife	13
DELICATE SCISSORS, sharp points	19	FRANCKE, blood lancet	06
DENHARDT, mouth gag	05	FRAZIER, fine wound retractor	69
DENIS-BROWENE, intestinal forceps	41	FRAZIER, suction instruments	163
DERRA, multi purpose clamps	122	FREER, fine wound retractor	69
DESCHAMPS, ligature needles	65	FREER, vascular spatulas	120
DESJARDINS, gall duct forceps	95	FRENZEL, tongue depressor	04
DESJARDINS, gall stone forceps	96	FRICKE, haemostatic forceps	56
DESJARDINS, gall stone scoops	95	FRITSCH, retractor	79
DESMARRES, wound and vein retractors	71		
DEMEL, Cerclage Instruments	148	<b>G</b>	
DIAGNOSTIC SETS	07	GALLAHER, rasp	126
DICK, vaginal clamps and compression forceps	59	GELPI, special retractors	82
DIEFFEBACH, bulldog clamps	49	GELPI, vaginal retractors	105
DINGMANN, bone holding forceps	142	GERALD, dissecting forceps	34
DISSECTING KNIVES	11	GIERTZ-STILLE, rib shears	126
Dissection Instruments	164	GILL, tissue forceps	37
Dissection Instruments	165	GILL-HESS, tissue forceps	37
Dissection Instruments	166	GILLIES, fine wound retractor	69
DITTEL, metal bougies	80	GILLIES, needle holder	63
DOYEN, abdominal retractors	79	GLOVER, bulldog clamp	49
DOYEN, intestinal clamps	87	GLUCK, rib shears	126
DOYEN, ovum forceps	230	GOOD, tonsil scissors	25
DOYEN, probes	66	GORNEY, suction instruments	163
DOYEN, towel clamps	48	GOSSET, abdominal retractors	84
DOYEN, vaginal specula	104	GRAEFE, fine wound retractor	69
DUROGRIP, Wire Holding forceps	149	GRAVE, vaginal specula	102
DUROTIP, Cutting Pliers	152	GROSS, dressing forceps	43
DUROTIP, Cutting Pliers	153	GUEDEL-NEGUS, laryngoscope	08
DUROTIP, Wire Cutters Cutting Scissors	151	GUTHRIE, fine wound retractor	69
DUVAL-COLLIN, Intestinal Grasping Forceps	46	GUYON, kidney clamps	97
DUPLAY, sponge and dressing forceps	43	GERALD, Tissue Forceps	38
DUVAL, intestinal forceps	41	GILLIES, Tissue Forceps	38
		GOLDSMITH, Nasal Specula	91
<b>E</b>		GRAEFE, Tissue Forceps	39
EISELSBERD, needle holder	63	GRAEFE, Tissue Forceps	39
ELSCHING, forceps	37	GRUENWALD, Forceps, Bayonet – Shaped	40
ENGL.MOD, towel clamps	48		
EPENDORF, biopsy forceps	115	<b>H</b>	
ESMARCH, cloth and plaster scissors	31	HALLE, vascular spatulas	120
EISELSBERG-MATHIEU, Needle Holders	64	HALSTED-MOSQUITO, haemostatic forceps	50
EXTRACTION PLIERS, Wire Holding forceps	150	HARTMANN, intestinal clamps	87



HARVEY, plate scissors	29	KELLY, tissue grasping forceps	44
HAJEK-KOFLER, Punches	130	KERN-LANE, bone holding forceps	143
HALSTED, Haemostatic Forceps	52	KERRISON-JACOBY, punches	129
HALSTED-MOSQUITO, Haemostatic Forceps	51	KERSTING, anastomosis forceps	89
HARTMANN, Ear Polypus Forceps	112	KELLY, Haemostatic Forceps	51
HARTMANN-HALLE, Nasal Specula	91	KERRISON, Punches	130
HARTMANN-HERZFELR, Ear Polypus Forceps	112	KILLIAN, bone shear	26
HARTMANN-HOFFMAR, Ear Polypus Forceps	112	KILLIAN, rectal spatula	90
HARTMANN-WULLSTEIN, Ear Polypus Forceps	112	KILNER, fine dissecting scissors	22
HARVEY, Wire Cutters Cutting Scissors	151	KILNER, fine wound retractor	69
HEANEY, needle holder	62	KILNER, dissecting scissor	22
HEGAR, needle holder	62	KILLIAN, Nasal Specula	90
HEGAR-OLSEN, needle holder	63	KIRSCHNER, Cutting Pliers	154
HEGER, uterine dilators	106	KIRSCHNER, Wire Extension	147
HEISS, haemostatic forceps	50	KOCHER, Haemostatic Forceps	52
HEISS, dressing forceps	58	KOCHER, Haemostatic Forceps	54
HEISTER, mouth gag	05	KOCHER-OCHSNER, Haemostatic Forceps	55
HENING, plaster spreader	157	KLIMA ROSEGGER, trocars	100
HERGET, biopsy forceps	113	KOCHER, retractor	71
HERTZLER, abdominal retractors	84	KOCHER, bladder retractors	99
HERTZLER, rib spreaders	127	KOCHER, bone retractor	74
HESS, tissue forceps	37	KOCHER, retractors	75
HEYMANN-KNIGHT, scissors	25	KOLLE, blood lancet	06
HEYWOOD-SMITH, ovum forceps	109	KONIG, elevators	135
HEYWOOD-SMITH, sponge holding forceps	44	KONIG, raspatories	137
HEYWOOD-SMITH, tongue forceps	05	KONISATION SMESSER, retractors	57
HOLLOW NEEDLE, Suction Instruments	159	KRAUSE, biopsy tip	115
HOUSE, Suction Instruments	161	KRISTELLER, vaginal specula	102
HUBER, biopsy forceps	115	KRISTELLER, vaginal specula	103
HUNT, tumor & vessel forceps	32	KRONECKER, suture instruments	65
HUNTER, splinter forceps	42	KRONLEIN, haemostatic forceps	56
		KUMMEL, intestinal spatula	80
<b>I</b>		<b>L</b>	
INGE, lamina spreaders	83	LABORDE, tracheal dilators	119
INTEROSSEOUS, cartilage knife	12	LAHEY, artery traction forceps	47
IVES-FANSLER, anoscopes	92	LAHEY, gall duct forceps	94
<b>J</b>		LANE TRETOWAN, bone levers	136
JACKSON BURROWS, retractors	82	LANE, bone holding forceps	143
JACOBSON, bone curettes	139	LANE, bone levers	136
JACOBSON, needle holder	61	LANE, tissue forceps	41
JAEGAR, fine wound retractor	69	LANE,towel clamps	48
JAMESON, dissecting scissor	22	LANGE-HOHMANN, bone levers	136
JAMESON, needle holder	62	LANGENBACK, bone levers	135
JANSEN, bone curettes	139	LANGENBECK, with treangle handle	70
JANSEN, bone rongeurs	144	LANGENBECK, flap knife	12
JOHNS-HOPKING, bulldog clamps	49	LARYNGEAL MIRRORS	06
JOLL (FRIEDMAN), retractors	82	LAWRENCE, ligature forceps	58
JOLL, vaginal retractors	105	LANDOLT, Suction Instruments	160
JONES, towel clamps	48	LANDOLT, Suction Instruments	161
JOSEPH, bone file	138	LANGENBECK, Ear Curettes	110
JOSEPH, dura and skin retractor	69	LEBSCHKE, rib shears	126
JOSEPH, raspatories	137	LEGUEU, bladder retractors	99
JUDD-MASSON, bladder retractors	99	LEKSELL-STILLE, bone rongeurs	145
JANSEN, FORCEPS, Bayonet – Shaped	40	LERICHE, intestinal spatula	80
<b>K</b>		LEWIS, bone file	138
KADER, intestinal spatula	80	LISTER, bandage scissor	30
KALT, needle holder	61	LISTER, cloth scissor	30
KELLY, ovum forceps	109	LISTER, sponge forceps	43
KELLY, anoscopes	92	LISTON, bone cutting forceps	146

LOCKHART-MUMMERY, probes	66	MULLER, dura and skin retractor	69
LOCKWOOD, Intestinal Grasping Forceps	46	MURPHY, head band	03
LUCAE, FORCEPS, Bayonet – Shaped	40	MUSEUX, tissue grasping forceps	47
LUER, Retractors	73	<b>N</b>	
LOCKLIN, delicate scissor	25	NASAL SCISSORS	25
LOPEZ-REINKE, suction instruments	163	NAUJOKS wire scissors	29
LOWER, gall duct forceps	94	NAIL SPLITTING, Finger Nail Instruments	155
LOWMAN, bone clamps	143	NEEDLE HOLDER, for micro surgery	48
LOWMAN-GERSTER, bone clamps	143	NEGUS, tonsil forceps	57
LOWMAN-HOGLUND, bone clamps	143	NELATON, probes	66
LUCAS, gouges	141	NELSON, lung dissecting forceps	41
LUER-KORTE, gall stone scoops	80	NISSEN, gall duct forceps	94
LURE, bone rongeurs	144	NOTO, ovum forceps	109
<b>M</b>		NOTO, sponge holding forceps	44
MAGILL, laryngoscope	07	NOVAK-SCHOECKAERT, biopsy curettes	111
MALTZ, rasps	138	NOYES, micro spring scissor	15
MANNERFELT, osteotomes	141	<b>O</b>	
MANNERFELT, retractors	70	OLIVECRONA, dura scissors	24
MARTIN, uterine probes	107	OLIVECRONA, trigeminal knife	13
MARTINI, bone curettes	139	OTOSCOPE SETS	07
MASING, retractors	71	OTOSCOPE, Diagnostic Sets	07
MASSON, needle holder	62	<b>P</b>	
MASSON-LUETHY, needle holder	62	PARTSCH, raspatories	137
MATHIEU, retractors	72	PARTSCH, gouges	141
MAYO, dissecting scissors	23	PARTSCH, raspatories	137
MAYO, uterine probes	107	PAYR, pylorus clamps	86
MAYO-HARRINGTON, dissecting scissors	23	PEAN, haemostatic forceps	57
MAYO-NOBLE, dissecting scissors	23	PEAN, haemostatic forceps	51
MAYO-STILLE, dissecting scissors	23	PEAN, kidney clamps	97
MARTIN, Nasal Specula	90	PEDERSON, vaginal specula	102
MATHIEU, Needle Holders	64	PEET, splinter forceps	42
MATHIEU-STILLE, Needle Holders	64	PELKMAN, uterine dressing forceps	108
MC INDOE, forceps	34	PERKINS, self retaining retractors	81
MC KENTY, raspatories	137	PIERCE, trocars	100
MEAD, mallets	140	PINARD, wooden stethoscope	02
MC INDOE, Tissue Forceps	38	PLESTER, retractors	81
MCINTOSH, laryngoscopes	09	PLESTER, suction instruments	163
MEDIUM, Dissecting Forceps	35	POOL, suction instruments	162
MICRO-HALSTED, Haemostatic Forceps	51	POTTS-SMITH, cardiovascular scissor	24
MILLIN, Needle Holders	64	PROBES	67
MICHEL, laryngeal mirrors	06	PARKER, Retractors	73
MICRO SCISSORS, laterally angled	17	PEAN, Haemostatic Forceps	52
MICRO-ADSON, forceps	33	PEAN, Haemostatic Forceps	53
MICRO-ADSON, forceps	37	PEAN, Haemostatic Forceps	54
MIDDELDORPF, retractors	75	PENNINGTON, Tissue Grasping Forceps	45
MIKULICZ, tissue forceps	57	PROVIDENCE-HOSPITAL, Haemostatic Forceps	51
MIKULICZ, intestinal spatula	80	<b>Q</b>	
MIKULICZ, retractors	78	QUERVAIN, bone levers	113
MILLER, laryngoscope	08	<b>R</b>	
MILLIN, bladder retractors	99	RABINER, neurological hammer	01
MIXTER, ligature forceps	58	RANDALL, biopsy curettes	111
MOD.USA, plaster spreader	127	RANDALL, kidney stone forceps	98
MORRIS, anastomosis clamps	89	RECAMIER, uterine scoops	116
MOYNIHAN, haemostatic forceps	57	REYNOLDS, dissecting scissors	22
MOYO-HEGAR, needle holder	62	RICHTER, vaginal retractors	105
MOD. WIEN, Nasal Specula	91	ROCHESTER-CARMALT, haemostatic forceps	57
MOLTGEN, Examination & Measuring Instruments	10	ROEDER, towel clamps	48
MULLAR, Wire Cutting Plier With T.C. Inserts	187		
MULLER LIGATURE FORCEPS	49		
MULLER VESSEL CLIPS	49		

ROUX, retractors	72	STERBERG, Retractors	
RUDD, haemorrhoidal ligator	93	STRULLY, cardiovascular scissors (pointed)	24
RUMEL, dissecting forceps	58	SUCTION INSTRUMENTS	162
RUSS-MODELL, tissue forceps	41	SURGICAL SCISSORS, incision	21
ROHRSCHEIDER, needle holder	61	SURGICAL SCISSORS, serrated	20
ROLLET, dura and skin retractor	69	SURGICAL SCISSORS, slender type	20
ROSER KONIG, mouth gag	05	SURGICAL SCISSORS, standard	20
RAMPLEY, Tissue Grasping Forceps	45	SURGICAL SCISSORS, standard	20
RANKIN, Haemostatic Forceps	52	SUTURING INSTRUMENT SET	68
REILL, Cutting Pliers	152	SYSTRUNK, nail splitting scissors	21
REPLACEMENT LAMP, laryngoscopes	09	SPENCER-WELLS, Haemostatic Forceps	
ROCHESTER-OCHSNER, Haemostatic Forceps	54	SYSTRUNK, Finger Nail Instruments	
ROCHESTER-PEAN, Haemostatic Forceps	53		
ROSE, Retractors	73		
ROUND PLIERS, Wire Holding forceps	150		
<b>S</b>		<b>T</b>	
SAENGER, ovum forceps	118	TAKAHASHI, rongeur	112
SAMII, tumor grasping forceps	32	TAYLOR, percussion hammer	01
SATINSKY, vena cava scissors	24	TAKAHASHI, Rongeurs	132
SAUPE, cilia forceps	42	THOREK, cardiovascular scissors	24
SCALPEL HANDLES	14	THORPE, corneal forceps	33
SCHAAF, cilia forceps	42	TIECK-HALLE, Nasal Specula	90
SCHAEDEL, towel clamps	48	TOENNIS, Wire Cutting Plier With T.C. Inserts	187
SCHEINMANN, biopsy forceps	115	TOWNLEY, Examination & Measuring Instruments	10
SCHIMMELBUSCH, ether mask	05	TOBOLD, tongue depressors	04
SCHMID, vascular spatulas	120	TOENNIS ADSON, dissecting scissors	22
SCHOEMAKER-LOTH, needle holder	63	TOENNIS, dissecting scissors	22
SCHOENBORN, retractors	71	TOENNIS, fine wound retractor	69
SCHRODER, uterine scoops	116	TOENNIS, vascular spatulas	120
SCHUMACHER, rib shears	126	TOENNIS, needle holder	63
SCHUMACHER, umbilical scissors	28	TRELAT, raspatories	137
SCHUMASHER, biopsy forceps	114	TRIGEMINAL KNIFE	13
SCOVILLE-RICHTER, retractors	67	TROCARS	100
SEGOND, myomatome	13	TROEMNER, percussion hammer	01
SEIDL, vaginal specula	102	TROUSSEAU, tracheal dilators	119
SEIDL-DBP, biopsy forceps	114	TROCAR, Suction Instruments	159
SELLORS, rib spreaders	128	TROELTSCH, FORCEPS, Bayonet – Shaped	40
SEMKEN, dissecting forceps	34	TUFFIER, rib spreaders	127
SEMKEN, tissue forceps	37	TUTTLE, lung dissecting forceps	41
SENN-MILLER, Retractors	73		
SEUTIN, plaster scissor	31	<b>U</b>	
SHAPLEIGH, Ear Curettes	110	UMBILICAL CORD SCISSORS	28
SIMON, uterine scoops	116	UNIVERSAL BANDAGE SCISSORS	30
SIMPLEX, tongue depressor	04	UNIVERSAL TROCARS	100
SIMPSON, uterine probes	107	US-ARMY, retractors	72
SIMPSON-BRAUN, obstetrics forceps	117		
SIMS, gynaecology scissors	27	<b>V</b>	
SIMS, vaginal specula	102	VANNAS, micro spring scissors	15
SIMS, rectal specula	90	VERNIER, Examination & Measuring Instruments	10
SIMS, uterine probes	107	WISE GRIP, Wire Holding forceps	150
SMOOTH JAWS FORCEPS	34	VOLKMANN, bone curettes	139
ST.MARTIN, tissue forceps	37	VOLKMANN, bone retractors	74
STEMBERG, tongue depressor	04		
STIEGLITZ, splinter forceps	42		
STILLE, bone rongeurs	145		
STILLE-AESCLAP, plaster shears	156		
STILLE-RUSKIN, bone rongeurs	145		
STRACK, wire scissor	29		
STRASSBURGER Tissue forceps	41		
STANDARD, Dissecting Forceps	35		
STANDARD, Tissue Forceps	39		

## W

WANGENSTEEN, needle holder	62
WARTENMERG, pinwheel	01
WAGNER, Rongeurs	134
WAUGH, Tissue Forceps	38
WEBER, anastomosis clamps	124
WECKER, eye scissors	15
WEIL-BLAKESLEY, rongeurs	112
WEITLANER, self retaining retractors	81
WERTHEIM, gynaecology scissors	27
WERTHEIM, clamps and forceps	59
WERTHEIM-CULLEN, vaginal clamps	60
WIEDER, tongue depressor	04
WEIL-BLAKESLEY, Rongeurs	132
WILLIGER, bone curettes	139
WILLIGER, elevators	135
WILLIGER, raspatories	137
WINTER, ovum forceps	118
WILDE, Forceps, Bayonet – Shaped	40
WOLFF, plaster breakers	157
WULLSTEIN, retractors	81
WULLSTEIN, Suction Instruments	160

## Y

YASARGIL, needle holder	61
YASARGIL, tumor grasping forceps	32
YASARGIL-SAMIL, tumor grasping forceps	32
YASARGIL, Suction Instruments	160
YASARGIL, Suction Instruments	161
YASRGIL, micro scissors	17
YEOMAN, biopsy forceps	113
YOUNG, tongue forceps	05
YOUNG- HRYNTSCHAK, Needle Holders	64
YOUNG-MILLIN, Needle Holders	64

## Z

ZENKER, ligature	58
ZENKER, retractors	77
ZIEGLER, head band	03
ZIEGLER, head mirror	03



**SIMZ MEDICAL SUPPLIES LLC**

Milwaukee, Wisconsin, USA

 +1 (414) 514-3542  
+1 (732) 513-4737

 [info@simzmedicalsupplies.com](mailto:info@simzmedicalsupplies.com)

 [www.simzmedicalsupplies.com](http://www.simzmedicalsupplies.com)